

norstar

.....

**Compact DR5
(with Disconnect
Supervision)
Installer
Guide**

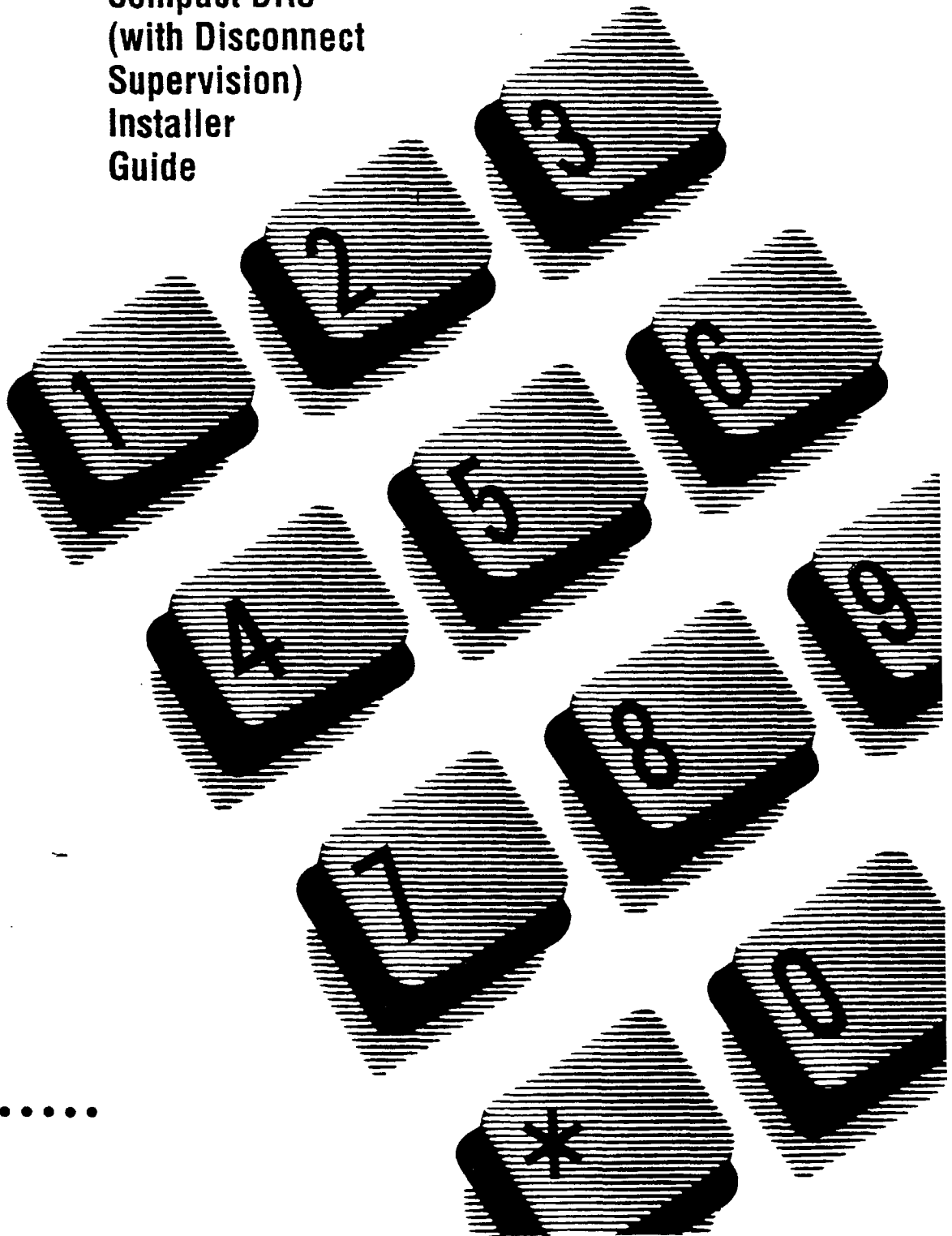

.....

**Compact DR5
(with Disconnect
Supervision)
Installer
Guide**

Norstar and Meridian are trademarks of Northern Telecom
© Copyright Northern Telecom 1995

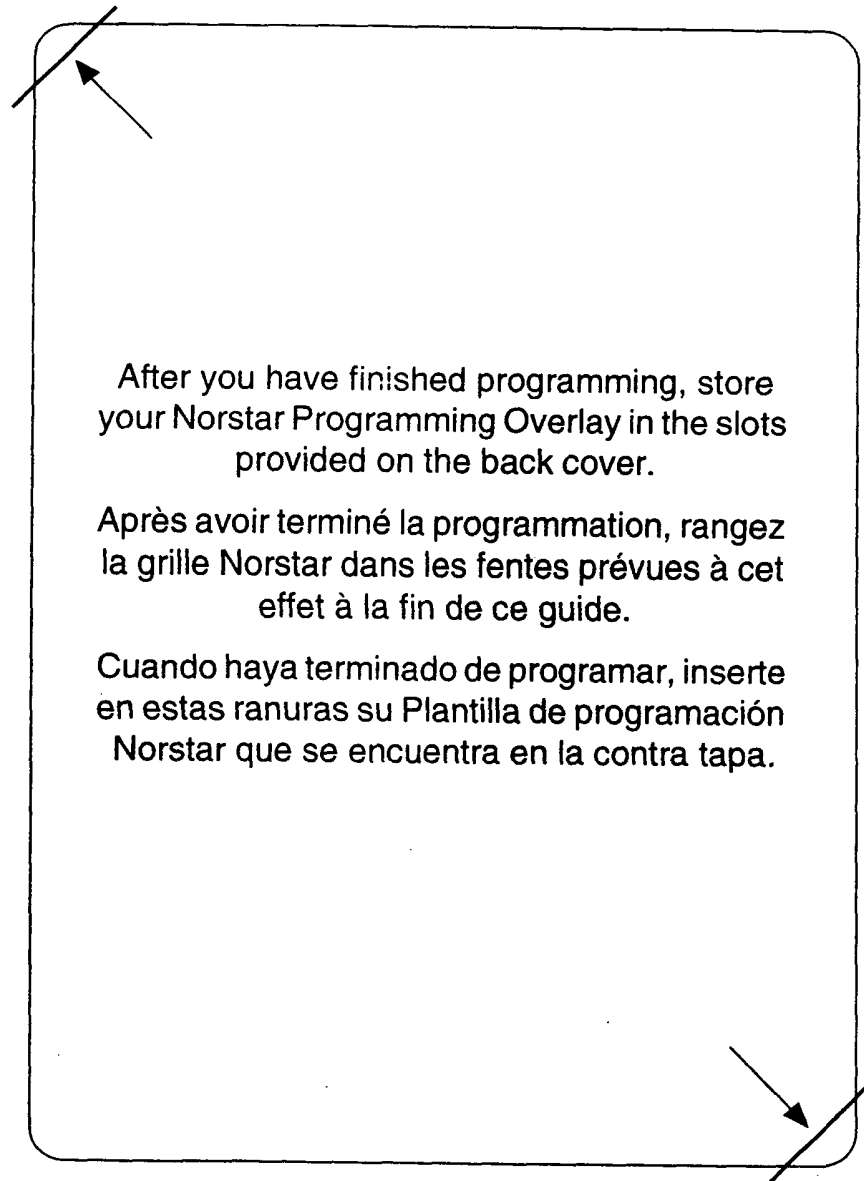
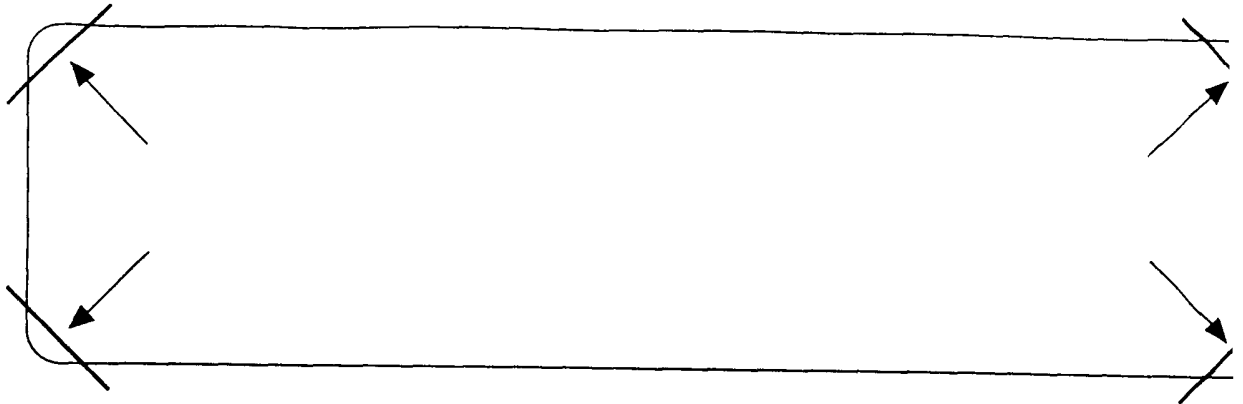

After you have finished programming, store your Norstar Programming Overlay in the slots provided on the back cover.

Après avoir terminé la programmation, rangez la grille Norstar dans les fentes prévues à cet effet à la fin de ce guide.

Cuando haya terminado de programar, inserte en estas ranuras su Plantilla de programación Norstar que se encuentra en la contra tapa.

Regulations

Radio Frequency Interference

WARNING

This equipment generates, uses, and can radiate radio frequency energy. If not installed and used in accordance with the instruction manual, it may cause interference to radio communications. It has been tested and found to comply with the limits for a Class A computing device pursuant to Part 15 of the FCC Rules, which are designed to provide reasonable protection against such interference when operated in a commercial environment. Operation of this equipment in a residential area is likely to cause interference, in which case the user, at his own expense, will be required to take whatever measures may be required to correct the interference. Each Norstar Key Telephone System is assigned an FCC Registration Number and a Ringer Equivalence designation. The number and designation are printed on the Key Service Unit (KSU) label on the front of the unit inside the door.

Registration

The Norstar Key Telephone System is registered with the FCC based upon compliance with Part 68 of its rules. Connection of the Norstar Key Telephone System to the nationwide telecommunications network is made through a standard network interface jack that you can order from your telephone company. Jacks for this type of customer-provided equipment will not be provided on party lines or coin lines.

Interconnect

Norstar Compact equipment meets all applicable requirements of both the Canadian Department of Communications CS-03 and US Federal Commission FCC part 68 and has been registered under files DOC 3322492A and FCC AB67UJ-17156-KF-E (key system) and AB67UJ-17338-MF-E (hybrid system).

Ringer Equivalence Number (REN)

The FCC Registration Label, on the inside of the door on the front of the Key Service Unit (KSU), includes the Ringer Equivalence Number (REN). This number shows the electrical load that your Norstar KSU requires from your telephone line. If the KSU requires more electrical current than your telephone company's central office equipment can provide, your telephones may not ring and you may have difficulty dialing telephone numbers.

Call the telephone company to find out the total REN allowed for your telephone line(s).

Hearing Aid Compatibility

Norstar telephones are Hearing Aid compatible, as defined in Section 68.316 of Part 68 FCC Rules.

Electromagnetic compatibility (EMC)

Radiated emissions

Norstar Compact equipment meets all FCC part 15, class A radiated emissions requirements.

Conducted emissions

Norstar Compact equipment meets all FCC part 15, class A conducted emissions requirements.

Safety

Norstar Compact equipment meets all applicable requirements of both the Canadian Standards Association C22.2 No. 0.7 M1985 and US Underwriter's Laboratory UL-1459, issue 1, and has been registered under files CSA LR58855-12 and UL E115515 88NK16650.

Telephone Company Registration

It is usually not necessary to call the telephone company with information on the equipment before connecting the Norstar Key Telephone System Key Service Unit (KSU) to the telephone network but, if the telephone company requires this information, provide the following:

- Telephone number(s) to which the Key Service Unit (KSU) will be connected
- FCC Registration Number
(on label affixed to KSU, inside the door)
- Ringer Equivalence Number
(on label affixed to KSU, inside the door)
- USOC Jack
RJ-21X
- Service Order Code
(SOC) 9.0 F
- Facility Interface Code
(FIC)02LS2

Use of a Music source

In accordance with U.S. Copyright Law, a license may be required from the American Society of Composers, Authors and Publishers, or similar organization if Radio or TV broadcasts are transmitted through the Music On Hold or Background Music features of this telecommunication system.

Northern Telecom Inc. hereby disclaims any liability arising out of the failure to obtain such a license.

This digital apparatus does not exceed the Class A limits for radio noise emissions from digital apparatus set out in the Radio Interference Regulations of the Canadian Department of Communications.

Rights of the Telephone Company

If the system is determined to be causing harm to the telephone network, the telephone company may discontinue your service temporarily. If possible, the telephone company will notify you in advance. If advance notice is not practical, you will be notified as soon as possible. You will be given the opportunity to correct the situation and you will be informed of your right to file a complaint to the FCC. Your telephone company may make changes in its facilities, equipment, operations or procedures that could affect the proper functioning of your system. If it does this, you will be notified in advance to give you the opportunity to maintain uninterrupted telephone service.

In the event of an equipment malfunction, all repairs will be performed by Northern Telecom Inc. or by one of its authorized dealers.

Address of a repair facility

USA

Northern Telecom Inc.
Product Service Center
640 Massman Drive
Nashville, TN
37210
Attn. RA# _____

Canada

Northern Telecom Canada Ltd.
150 Montreal-Toronto Blvd.
Building C, Doors 33 and 34
Lachine, Quebec
H8S 1B6

Contents

Preparation 1-1

- KSU Location requirements 1-1
 - Mounting requirements 1-1
 - Equipment for mounting the KSU 1-2
 - Internal wiring requirements 1-2
 - Electrical requirements 1-2
 - Norstar as an OPX 1-3
-

Installing the KSU 2-1

- External lines and internal wiring 2-2
 - Internal wiring chart 2-3
 - Installing the Emergency Telephone 2-4
 - Testing the Emergency Telephone 2-4
-

Installing Norstar telephones 3-1

- Installing a wall-mounted telephone 3-2
-

Installing optional equipment 4-1

- Auxiliary Ringer (Customer Supplied) 4-1
 - External Music source (Customer Supplied) 4-1
 - External Paging (Customer Supplied) 4-2
-

Powering up the KSU 5-1

Programming 6-1

- Programming overview 6-1
- System Startup 6-1
- Configuration 6-1
- General Administration 6-1
- Set Copy 6-2
- System Version 6-2
- Programming tools 6-4
- Norstar Telephones 6-4
- Programming Record 6-4
- Programming Overlay 6-4

System Startup	6-6
System Startup access	6-6
Entering System Startup	6-7
Choosing the system template	6-8
Configuration	6-10
Configuration access	6-10
Installer Password	6-10
Trk/Line Data	6-12
Line Access	6-16
Call Handling	6-19
Miscellaneous	6-22
System Data	6-26
Set Copy	6-27
Set Copy Options	6-27
Telephone settings which CANNOT be copied	6-28
Telephone settings which CAN be copied	6-29
Entering Set Copy	6-31
System Version	6-32
Entering System version	6-32

Troubleshooting 7-1

Testing the lines and phones	7-1
Analog Terminal Adapter (ATA) trouble	7-2
Auxiliary Ringer trouble	7-2
Call Identification Interface	7-3
Dial tone absent (on external lines)	7-3
External Paging trouble	7-4
Hung lines at a telephone	7-4
KSU down	7-5
Music on Hold/Background Music trouble	7-5
Telephone dead	7-6

Finishing up 8-1

Applying the button labels	8-1
For the customer	8-1
Personal programming	8-2
Call Display services	8-2

Preparation

Check the location where the Norstar system KSU, the telephones, and auxiliary equipment are to be installed.

KSU Location requirements

- Clean, dry, and well-ventilated
- Temperature: 0°C to 50°C (32°F to 122°F)
- Humidity: 5% to 95%, non-condensing
- Location: at least 4 m (13.1 ft) from equipment such as photocopiers, electrical motors, and other equipment that can produce electromagnetic, radio frequency, and electrostatic interference.

Mounting requirements

If a smooth surface is not available, cut a backboard large enough to accommodate the system KSU and the distribution panel.

Chart 1 — KSU dimensions and required clearances

Dimension	Measurement	
Length	55.6 cm	(21.9 in)
Width	35.6 cm	(14 in)
Height	8.7 cm	(3.4 in)
Weight	5.25 kg	(11.6 lb)
Clearance (front)	1 m	(39.4 in)
Clearance (top)	30 cm	(11.8 in)
Clearance (bottom)	30 cm	(11.8 in)

Equipment for mounting the KSU

- screwdriver, diagonal cutters, pliers, connecting tool, pencil, level (optional)
- three 5mm (#10) wood screws, 38 mm (1½ in) long
- 19 mm (¾ in) thick wooden backboard (if necessary)

Internal wiring requirements

All new or existing wiring must meet the following specifications:

- one twisted pair per telephone
- a dc loop resistance less than 59 Ω
- cable length (0.5 mm or 24 AWG) not to exceed 305 m (1000 ft)
- use of a Norstar Station Auxiliary Power Supply (SAPS) to extend the loop up to 790 m (2600 ft) if the cable is longer than 305 m (1000 ft)
- no bridge taps

Electrical requirements

- Non-switched outlet
- ac outlet located not more than 1.5 m (4.9 ft) from the Key Service Unit (KSU)
- For 120V product: dedicated 110 to 120V ac nominal, 50/60 Hz, 15 A minimum service with third wire ground
- For 220V product: dedicated 220 to 240V ac nominal, 50/60 Hz, 15 A minimum service with third wire ground
- For 48V product: refer to the insert packaged with your 48V KSU for specific installation instructions

WARNING

The ac outlet must be equipped with a third wire ground to avoid electromagnetic interference.

Norstar as an OPX

Norstar can be used as an off-premise extension (OPX) from a PBX. In order to support this application, the OPX lines must be engineered not to exceed 8 dB total loop loss from the serving central office to the demarcation point at the Norstar KSU.

telemanuals.com

Installing the KSU

Note: Mount the KSU on a backboard with at least 10 cm (3.9 in) of clearance on its left-hand side, and at least 5 cm (2 in) of clearance on its right-hand side (viewed from the front of the KSU).

1. Unpack the KSU and inspect it for damage.
2. Before installing the KSU, open the KSU door 90°. Applying upward pressure, lift the door from its hinges.
3. **Do not turn the power on to the KSU.**
4. Screw the top mounting screw half-way into the backboard.
5. Hang the KSU vertically on the top mounting screw (Figure 1).
6. Make sure the KSU is level.
7. Install the bottom and right-hand side screws. Tighten all screws.
8. Following the instructions on the label, install the Software Cartridge (Figure 2).

Figure 1 — Mounting the KSU

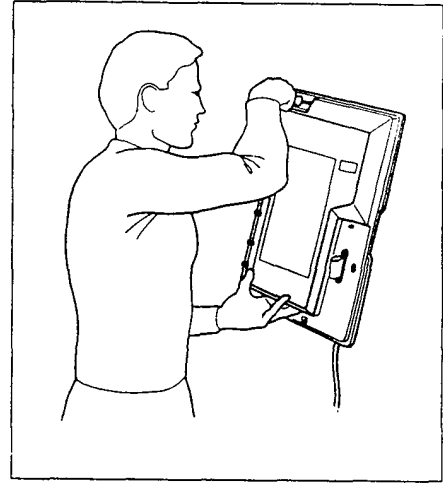
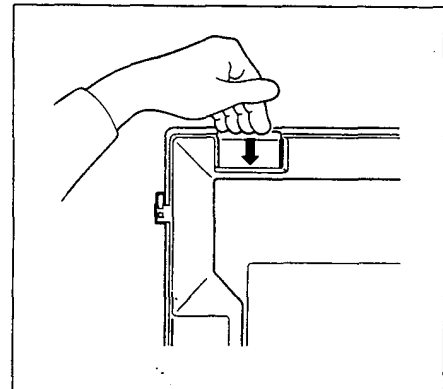

Figure 2 — Inserting the Software Cartridge



CAUTION

Never install or remove the Software Cartridge when the KSU power is on.

External lines and internal wiring

Connecting external lines

1. Cross-connect the external lines from the distribution panel directly to the modular jacks located on the left side of the KSU. Line 01 is connected to the bottom jack. (Each jack is identified with its line number.)
2. Route the line cords on the KSU (Figure 3).

Connecting internal wiring

1. Plug the 25-pair cable into the KSU (Figure 4).
2. Route the cable to the distribution panel.
3. Connect the wires to the appropriate pins on the distribution block. (See Chart 2 — Internal Wiring.)
4. Cross-connect the internal wires to the corresponding pins on the distribution block.
5. Connect the Norstar telephones to your internal wiring loop. A pair of wires is required for each internal telephone. (See Chart 2 — Internal Wiring.)

Figure 3 — Routing the line cords

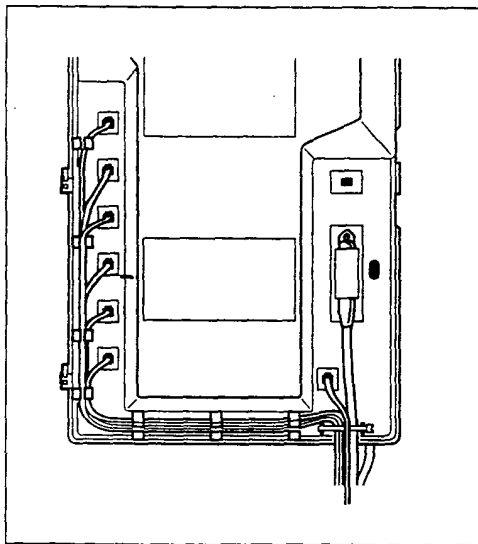
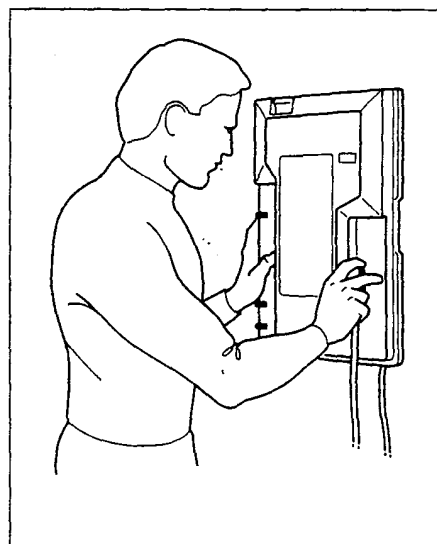

Figure 4 — Plugging in the 25-pair cable



Internal wiring chart

Chart 2 — Internal Wiring

50-Pin Distribution Block				
Pin	Wire Color	Service	Telephone (Defaults)	Port
26 1	White-Blue Blue-White	T R	(21)	1
27 2	White-Orange Orange-White	T R	(22)	2
28 3	White-Green Green-White	T R	(23)	3
29 4	White-Brown Brown-White	T R	(24)	4
30 5	White-Slate Slate-White	T R	(25)	5
31 6	Red-Blue Blue-Red	T R	(26)	6
32 7	Red-Orange Orange-Red	T R	(27)	7
33 8	Red-Green Green-Red	T R	(28)	8
34 9	Red-Brown Brown-Red	T R	(29)	9
35 10	Red-Slate Slate-Red	T R	(30)	10
36 11	Black-Blue Blue-Black	T R	(31)	11
37 12	Black-Orange Orange-Black	T R	(32)	12
38 13	Black-Green Green-Black	T R	(33)	13
39 14	Black-Brown Brown-Black	T R	(34)	14
40 15	Black-Slate Slate-Black	T R	(35)	15
41 16	Yellow-Blue Blue-Yellow	T R	(36)	16
42 17	Yellow-Orange Orange-Yellow	Spare Spare		
43 18	Yellow-Green Green-Yellow	Spare Spare		
44 19	Yellow-Brown Brown-Yellow	Spare Spare		
45 20	Yellow-Slate Slate-Yellow	Spare Spare		
46 21	Violet-Blue Blue-Violet	Spare Spare		
47 22	Violet-Orange Orange-Violet			External Paging (audio signal)
48 23	Violet-Green Green-Violet	N/O Common		External Paging (relay contact)
49 24	Violet-Brown Brown-Violet	N/O Common		Auxiliary Ringer (relay contact)
50 25	Violet-Slate Slate-Violet	Music Ground		External Music (audio signal)

Note: T and R are symbolic representations of the telephone connections and should not be confused with Tip & Ring. Telephone connections are non-polarized.

Installing the Emergency Telephone

An optional Emergency Telephone (ET) automatically connects to Line 01 when the power fails or when power to the KSU is disconnected.

Note: Use only a standard 500/2500 single-line telephone for this purpose.

1. Connect the customer supplied Emergency Telephone to the Emergency Telephone (ET) jack on the lower right hand corner of the KSU panel.
2. Label the telephone: "Emergency Telephone Only. This telephone functions only when ac power to the telephone system is turned off."

Testing the Emergency Telephone

The Emergency Telephone must be tested with the KSU power off.

1. Pick up the Emergency Telephone receiver.
If you hear a dial tone, both the Emergency Telephone and Line 01 are functioning properly.
OR
If you hear no dial tone, check Line 01. Unplug the Emergency Telephone and connect it directly to Line 01 on the distribution block.
2. If you still do not hear a dial tone, check the line connections and operation of the Emergency Telephone.
3. If the previous steps have been verified and there is still no dial tone at the Emergency Telephone, replace the KSU.
4. Repeat the Emergency Telephone test.

Installing Norstar telephones

telematerials.com

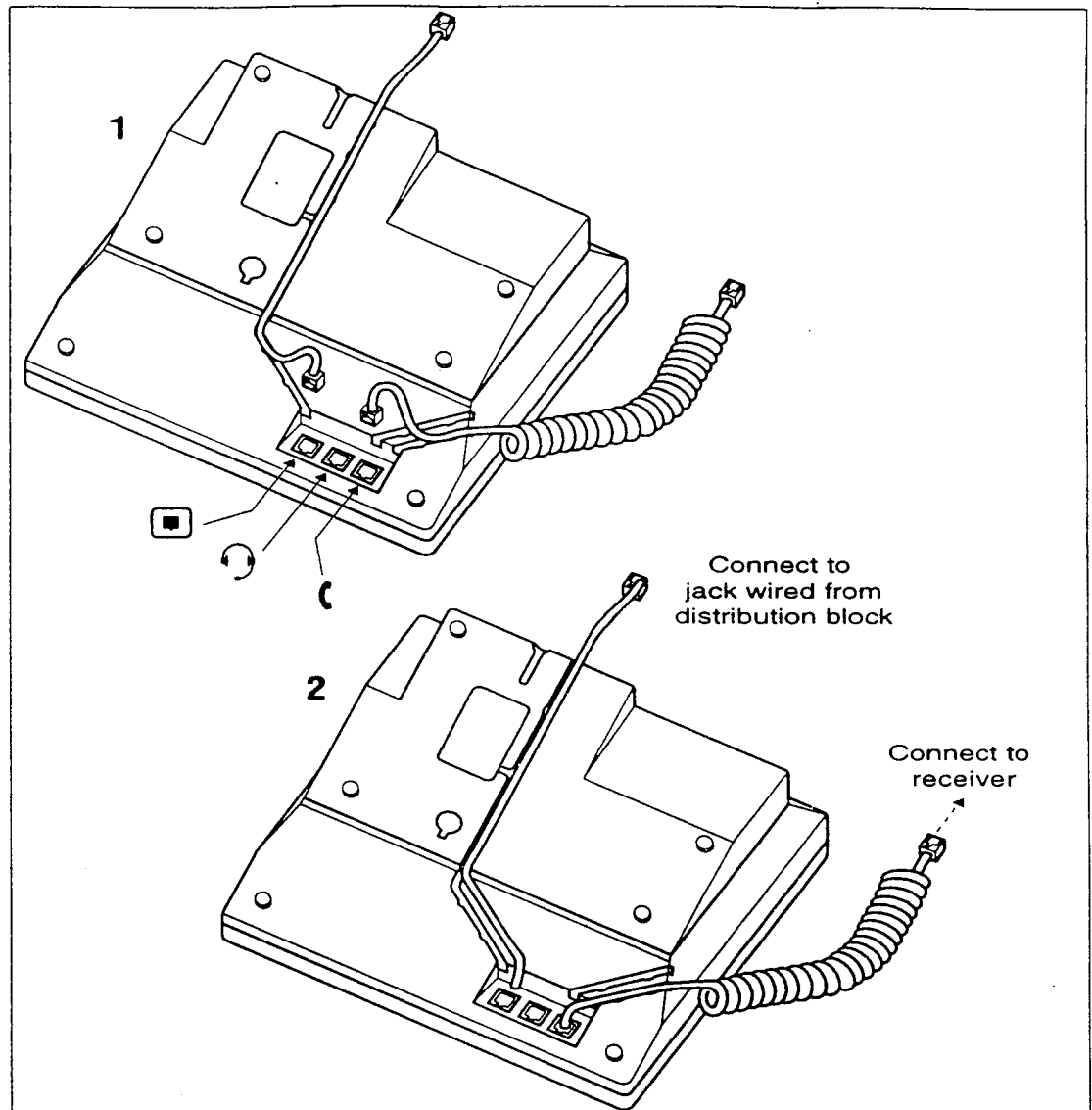

Norstar telephones cannot be used as off-premise extensions (OPX). For OPX applications, use the Norstar Analog Terminal Adapter (ATA) and a single-line telephone. (See the ATA installation card for details.)

Installing a wall-mounted telephone

1. Remove the beveled wall-mounting base from the back of the telephone. Grip the telephone, and with your thumbs, push on the wide edge of the base to pop it out from the telephone.

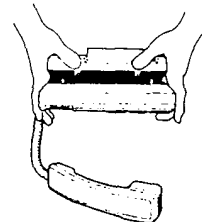

2. Remove the receiver clip from the wall-mounting base. Install the clip in the forward lip of the receiver rest.

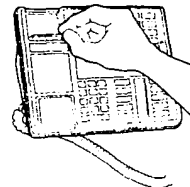

3. Use a screwdriver or similar tool to remove the center knock-out panel in the wall-mounting base.

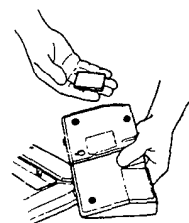

4. Screw the base to the wall (thin end up) so that the wall jack projects through the knock-out.

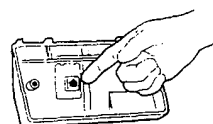

5. Connect one end of the line cord to the telephone line jack (indicated by the symbol below).

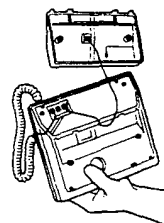

6. Route the line cord through the appropriate cord guide in the bottom of the telephone.

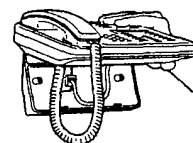

7. Connect the other end of the line cord to the wall jack. Store any spare cord neatly in the base of the telephone and mount the telephone on the base.

WARNING

If the telephone line is supported with auxiliary power, the power source must be a Class 2 power source that is UL and CSA Listed.

Installing optional equipment

telemanuals.com

Note: Optional equipment must meet with local regulatory approval standards.

Auxiliary Ringer (Customer Supplied)

The Norstar KSU provides a control contact to operate an external ringer. It does not provide ring current or dc voltage. The ringer relay contacts must not draw more than 50 mA from a 30 Vdc source.

1. Follow the manufacturer's installation instructions.
2. Connect the Auxiliary Ringer generator to the 50-pin distribution block as shown in Chart 2 — Internal Wiring.

External Music source (Customer Supplied)

This equipment provides music for the Music on Hold and Background Music features. These features must be enabled through Configuration (see the Programming chapter in this Guide). Refer to the *Compact DR5 System Coordinator Guide* and *Compact DR5 Programming Record* for more information.

The music source can be any approved low-power output device (such as a radio) with a high-impedance earphone jack. The recommended KSU input level is 0.25 Vrms across an input impedance of 3300 Ω .

CAUTION

To avoid damage to audio equipment, ensure that the polarity of the audio input is correct according to the KSU internal wiring chart.

1. Connect the music source and ground to the 50-pin distribution block as shown in Chart 2 — Internal Wiring.
2. Activate the Music on Hold or Background Music feature and adjust the volume at the music source to a comfortable level.

4-2 / Installing optional equipment

Note: Background Music volume for each telephone can also be controlled at the telephone.

External Paging (Customer Supplied)

The paging system uses the speakers on Norstar telephones and can also be used with external loudspeakers provided by the customer. The paging output from the Norstar KSU is 775-mVrms across an input impedance of 600 Ω .

1. Follow the manufacturer's installation instructions.
2. Connect the paging system audio input to the 50-pin distribution block as shown in Chart 2 — Internal Wiring.
3. Connect the paging relay (max. rating: 30 Vdc @ 50 mA) to the 50-pin distribution block as shown in Chart 2 — Internal Wiring.

Note: Norstar external paging does not support talk-back paging equipment unless an external line port is used.

Powering up the KSU

1. Power on the KSU by plugging in the power cord. The red power LED on the KSU should turn on.
2. If the red LED does not turn on, verify that there is power at the ac outlet.
OR
If there is power at the ac outlet, replace the KSU.

Note: Re-install the KSU door once the system is operational.

Programming

Programming a newly installed Norstar system involves the completion of the following programming steps:

- System Startup
- Configuration
- General Administration

Programming overview

System Startup

System Startup is performed only when the system is first installed. System Startup allows you to select one of three programming templates: Square, Hybrid, or PBX. Each template initializes all of the programming data to system wide defaults.

Configuration

Allows programming of basic line and telephone characteristics.

Configuration access code: This code and the Installer password give access to:

- A. Configuration
- B. General admin
- C. Set copy
- D. System Version

General Administration

Allows the customization of the system at installation and on an ongoing basis. (See the *Compact DR5 System Coordinator Guide* for details on Administration programming.)

Administration access code: This code gives access to:

Note: B. General admin is also accessible through the Configuration code. Administration has been given a unique code and optional password so that the System Coordinator can be allowed access to Administration programming, while being denied access to all other programming headings.

Set Copy

This feature is used to copy all of the system programming (Configuration and Administration) from one telephone to another. Personal programming on individual telephones can also be copied, but system-level programming will be copied along with it. Copy appears on the display as C. *Set copy* and is accessible through Configuration programming.

System Version

System Version allows you to note the version numbers of the software in the System Processor (SP) software, residing in the Software Cartridge. System Version appears on the display as D. *System Version* and is accessible through Configuration programming.

Chart 3 — Programming Overview

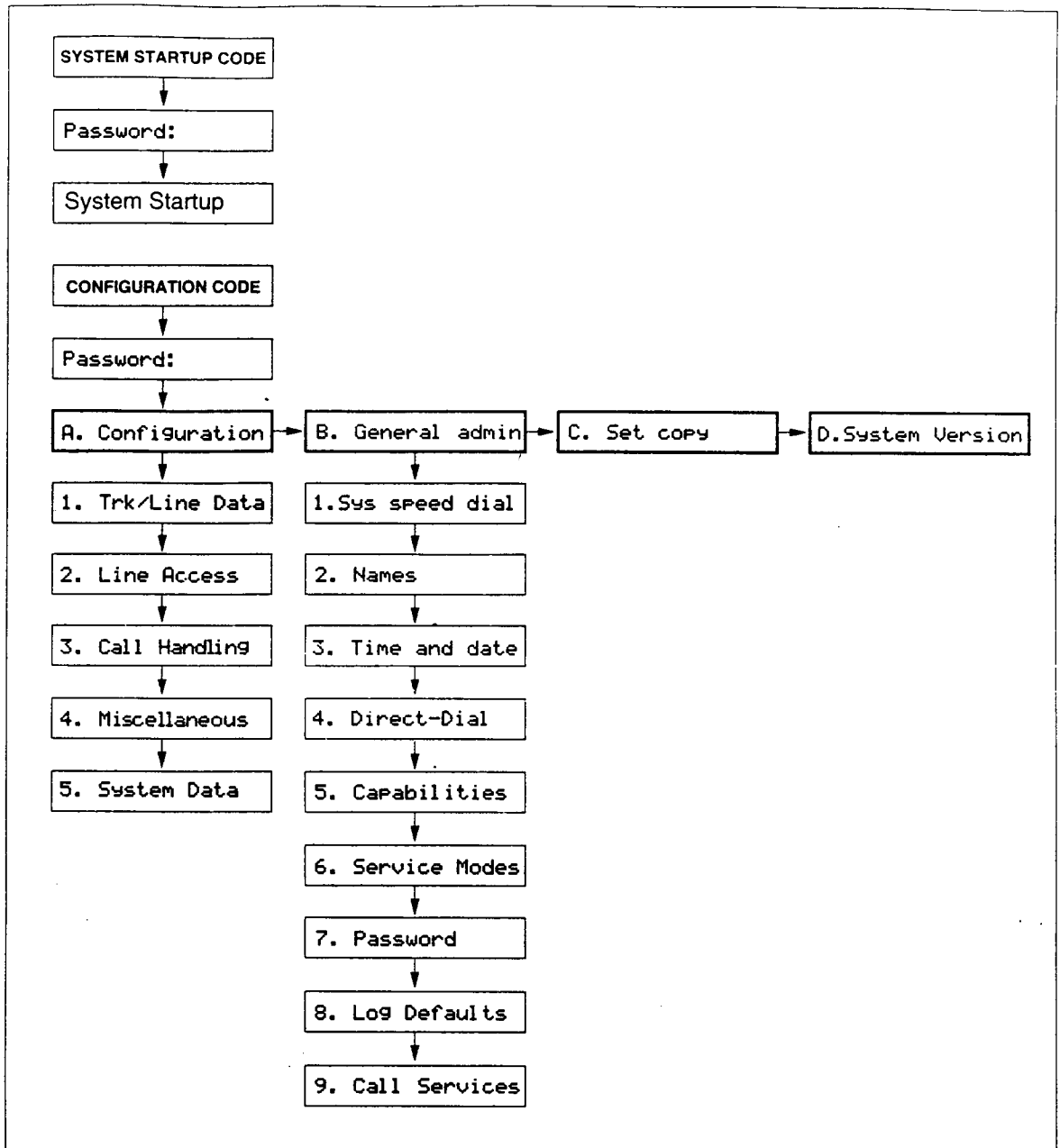

Programming tools

Norstar Telephones

The Norstar M7100, M7208, M7310 and M7324 Telephones can be used with the Compact DR5 system. Programming is done with an M7208, M7310, or M7324 Telephone (Figure 5). The M7100 Telephone cannot be used for programming.

Figure 5 — Norstar Telephones used for programming



Programming Record

The *Compact DR5 Programming Record* may already have been completed before installation. It describes the settings to be programmed into a Norstar system. Also, the *Compact DR5 Programming Record* serves as a record of the settings programmed at initial installation and during subsequent customization of the system.

Default settings: Many of the programming settings are determined during System Startup according to the selected template. Any of these settings may later be changed during programming. In the *Compact DR5 Programming Record*, these default settings are shown in bold characters for the Square template.

Programming Overlay

The Programming Overlay is placed over the buttons of the Norstar telephones, and provides an aid in recognizing the function of the buttons during programming. The Programming Overlay can be found at the end of this Guide.

The Programming Overlay for the M7208 Telephone is placed over all of the eight memory buttons (Figure 6). The Programming Overlay for the M7310 and M7324 Telephones (Figure 6) is placed over the top four memory buttons with indicators.

Figure 6 — Programming Overlay for the M7208 Telephone (top) and for the M7310 and M7324 Telephones (bottom)

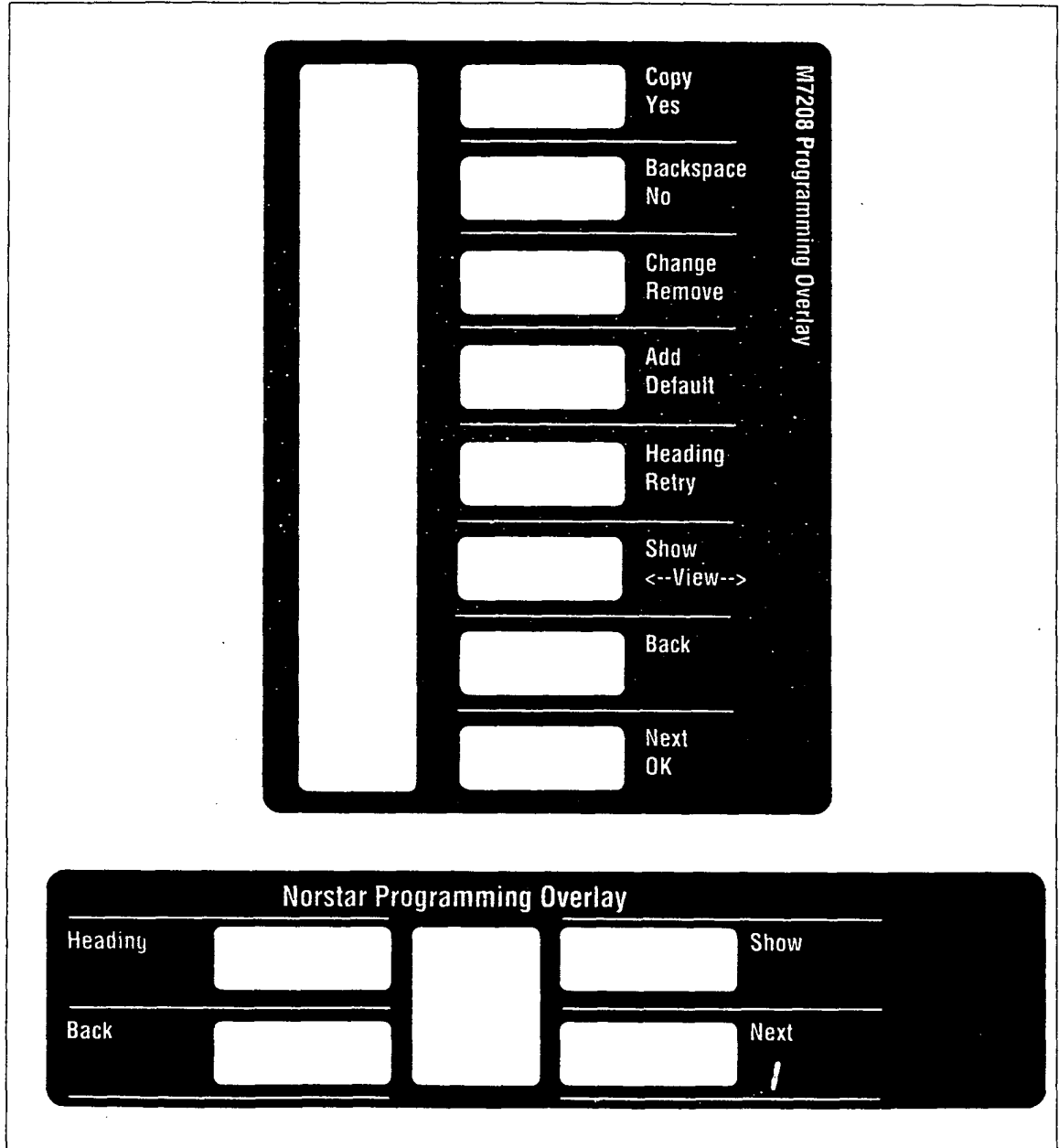

System Startup

Perform System Startup after the system hardware has been installed and powered up.

CAUTION

Startup is to be used for initial installation only, or after a system software upgrade with a new Software Cartridge. Do not use Startup after Norstar is in operation; the procedure erases all system administrative data.

All Configuration and Administration data will be retained for at least three days if the power fails or if the Norstar system is powered off. After three days without power, it may be necessary to perform System Startup again.

Note: Do **not** attempt Directory Number (DN) changes within two minutes of System Startup (using the Change DN's option of 5. *System Data*). Attempting a DN change may disable the ports.

System Startup access

The System Startup code and a password are used only by Installers to access System Startup.

The correct Startup code must be entered no later than 15 minutes after the Norstar system has been powered up. A Startup code entered at any time after the 15 minute interval results in the message *Startup denied*. If this occurs, re-power the system again to prepare for the System Startup process.

Entering System Startup

Note: If at any time you do not wish to continue with entering System Startup, press .

1. Select a Norstar telephone from which to program. Place the correct Programming Overlay over the buttons of the telephone. A button may be used during programming when its indicator  turns on.
2. Using the telephone dial pad, enter the System Startup code:

Which is the same as:

3. At the **Password:** prompt, enter the Installer password:
(The Installer password is not shown on the display.)

The default password is which is the same as . You will have to use the default if this is the first time that Configuration programming has been accessed. If Startup must be performed on an existing system which has already been programmed, the Installer password might have been changed. The change should have been recorded in the *Compact DR5 Programming Record*.

4. If the password is entered correctly, the display shows **Reset memory?** Proceed to change the system template as described in the next procedure.

OR

If the Password has been entered incorrectly, **Password:** remains on the display. Press the **RETRY** display button (or on the M7208 Telephone) and re-enter the correct password.

Note: For the security of system data, do not inform anyone that the Installer password is used for System Startup.

Choosing the system template

System Startup is used during initial installation to choose the appropriate template before starting programming. There are three templates available:

Square: Line 01 and Line 02 are assigned to each telephone.

Hybrid: Each telephone has access to Line Pool A and is assigned Line 01.

PBX: Each telephone has access to Line Pool A, but does not have a line assigned.

1. The display shows `Reset memory?` To continue with System Startup and choose the system template, press YES (or on the M7208 Telephone).

OR

To exit from System Startup, press CANCEL (or on the M7208 Telephone).

2. The display shows `Template: Square`. To accept the Square template, go to step 3.

OR

To select another template, press CHANGE (or on the M7208 Telephone) to select another template.

3. To accept the template shown and exit from System Startup, press . System Startup is complete when the default time and date appear on the telephone display.

Chart 4 — System Startup

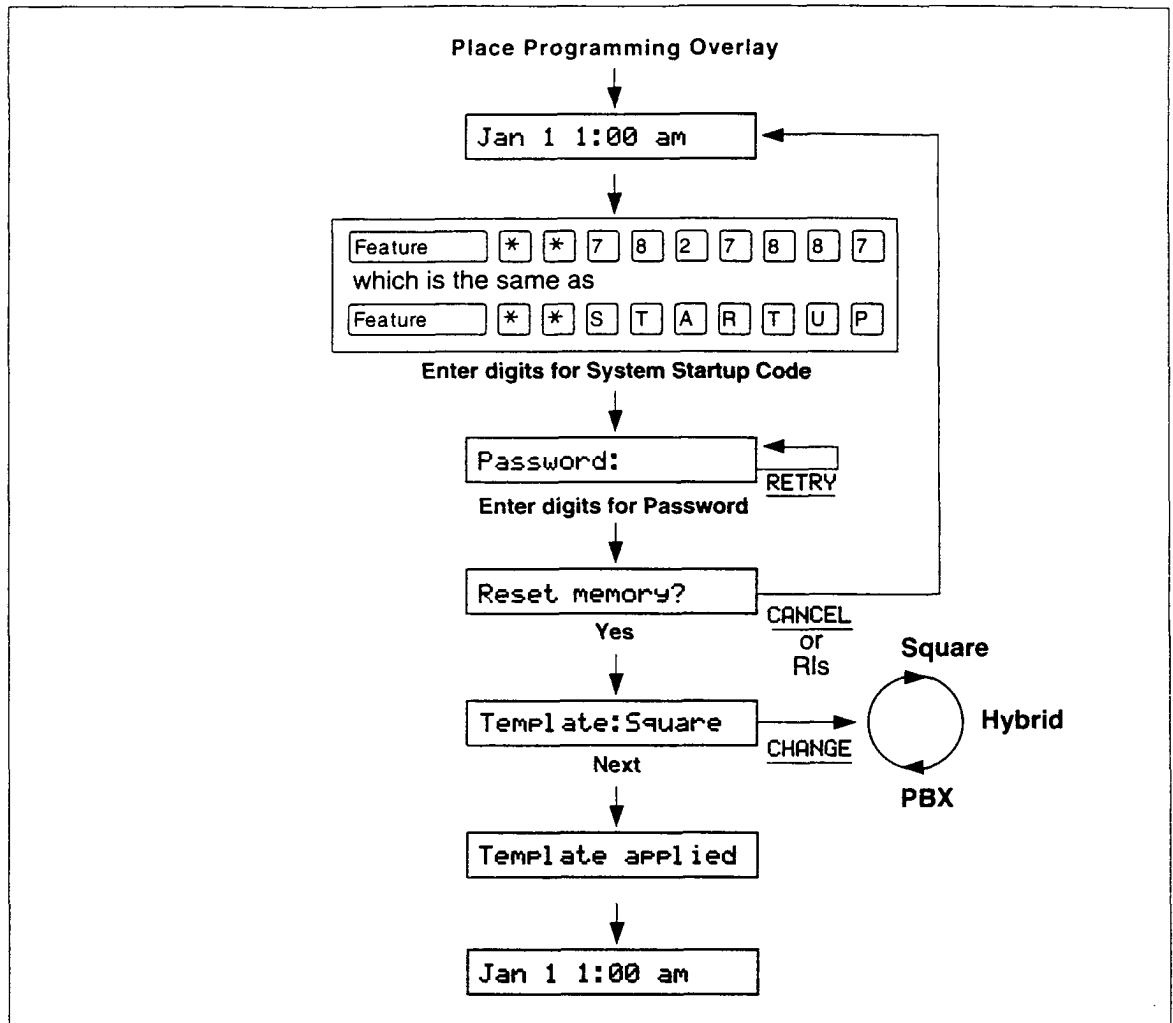

Configuration

A. Configuration programming allows you to specify basic system characteristics for the customer site. Configuration is not accessible to System Coordinators.

Configuration provides access to the following programming sections:

1. Trunk/Line Data
2. Line Access
3. Call Handling
4. Miscellaneous
5. System Data

Configuration access

1. Press * * 2 6 6 3 4 4 which is the same as * * C O N F I G .

Note: For the security of Configuration data, do not give the Configuration code to anyone.

Installer Password

1. At the **Password:** prompt, enter in the existing Installer password. The default password is 2 6 6 3 4 4 which is the same as C O N F I G . You will have to use the default password if this is the first time that Configuration programming has been accessed.
2. If the password is entered correctly, the display shows
A. Configuration.
OR
If the Password has been entered incorrectly, **Password:** remains on the display. Press **RETRY** (or) on the M7208 Telephone) and re-enter the correct password.

Chart 5 — Configuration Overview

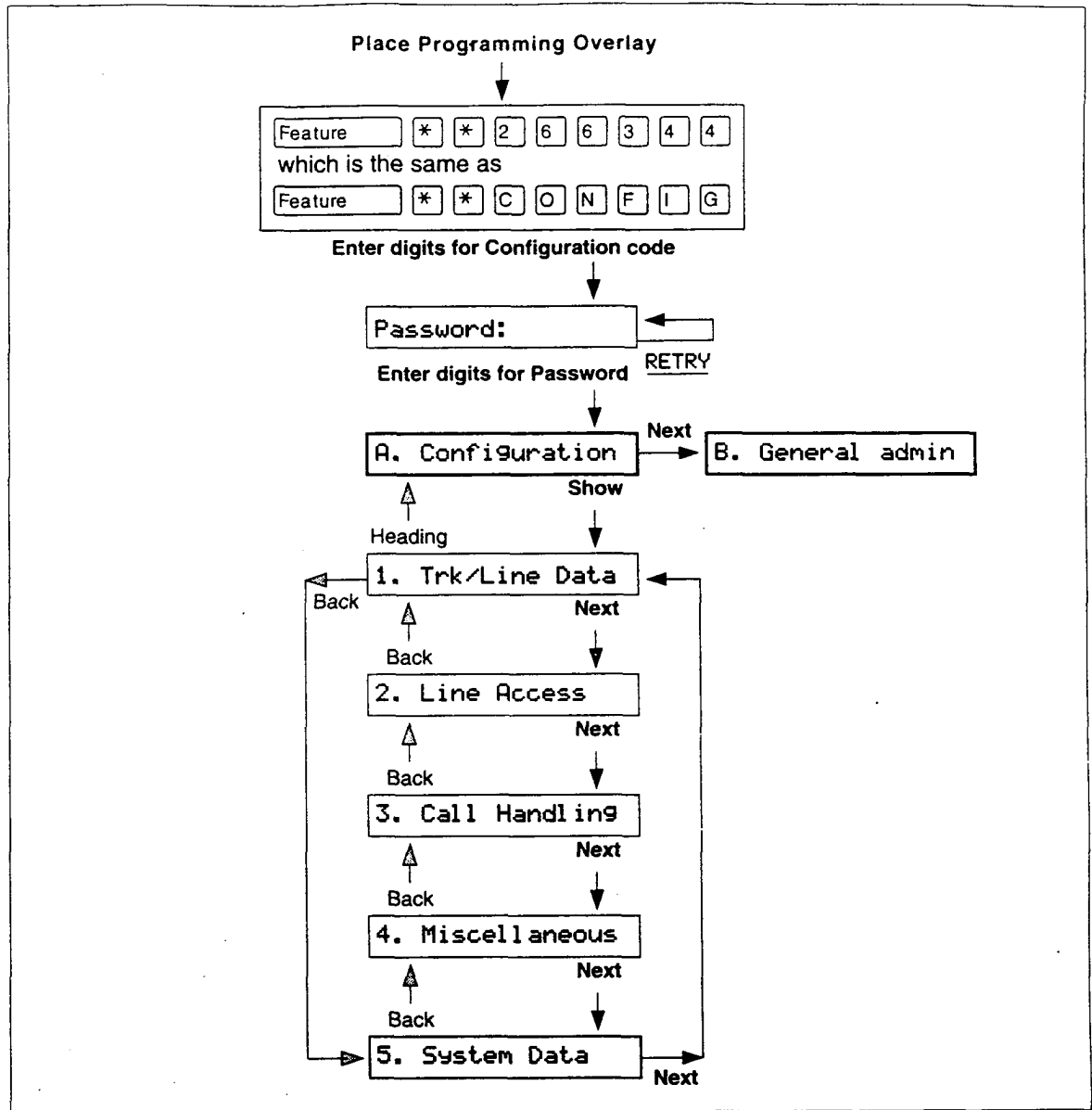

Trk/Line Data

Use 1. Trk/Line Data to program characteristics for each external line.

When you are finished programming the Trk/Line Data settings for a line, you may copy those exact settings to another line by using the COPY display button (or on the M7208 Telephone) at the Show line:_ prompt.

Entering the line to be programmed

Enter any available line number between 01 and 06.

Trunk data

Trunk data settings apply to external lines and include Trunk mode, Dial mode and Full Autohold.

Trunk mode

Trunk mode lets you specify one of two modes of operation for each line: disconnect supervised or unsupervised. The possible settings are Super or Unspr. Super turns disconnect supervision on for the line. Unspr turns disconnect supervision off for the line. The default is Unspr.

Disconnect Supervision, also referred to as loop supervision, releases an external line when an Open Switch Interval (OSI) is detected during a call on that line. This prevents the line from remaining unavailable for other Norstar users.

You should only assign the supervised mode to CO lines that provide an Open Switch Interval (OSI) message. The use of lines that do not have the OSI feature available (or lines set as unsupervised) for incoming calls, results in the inconsistent operation of the Line Redirection feature, the ability to disconnect from a conference that involves two external callers, and the ability to transfer an incoming external call to an external number.

- The duration of an OSI before Norstar disconnects a call is programmed in the Disconnect Supervision delay setting of Miscellaneous programming.

Dial mode

A dial mode can be assigned to each line. The mode defines the signaling that the line will use. The default mode is Pulse. The other possible mode is Tone.

- Lines that use Dual Tone Multi Frequency (DTMF) tones, should be set to Tone.

Full Autohold

If you select an idle line, but do not dial any digits, that line is automatically placed on hold when you select another line. The default setting is No, which means that the external line is not held. The other possible setting is Yes.

Line data

Line data settings apply to external lines and include Line type, Prime telephone, Auxiliary ringer and Auto privacy.

Line type

A type can be assigned to each line. The type defines how the line is to be used in relation to other lines in the system. The default type is Public. Other possible types are Private, Pool A, Pool B and Pool C.

- If you define a line as Public, the line can be accessed by more than one telephone.
 - If you define a line as Private, the line can only be assigned to one telephone and the Prime Telephone for that line.
 - If you assign a line to a Line Pool, that line can be available to any telephone that is assigned access to that Line Pool.
 - If a line is assigned to one of the three Line Pools, but the line is not assigned to any telephone, that line can only be used for making outgoing calls.
-

- If a line is assigned to one of the three Line Pools, you must remember that there are still two more programming settings that must be assigned before a Line Pool can be used:
 - You must assign Line Pool Access to telephones in Line Access.
 - You must assign Line Pool access codes in Miscellaneous programming.

Prime telephone

The Prime telephone provides backup answering for the selected line. The default Prime telephone has the internal number 21. Other possible settings are any allowable internal numbers, or None.

- Each line can only have one Prime telephone.
- Any Prime telephone can be assigned to provide backup answering for more than one external line. All of these lines do not necessarily have to appear on a line button with an indicator; however, monitoring lines is made easier if there is a line button for every external line.

Auxiliary ringer

An auxiliary ringer can be enabled or disabled for calls coming in on the line. The default setting is Yes, which means that the ringer will ring. The other possible setting is No.

Auto privacy

Select Yes (the default) to prevent other users who have access to a line on their telephone from using that line while a call is already in progress on the line. Select No, to allow a user to select a line in use at another telephone, and join an established call.

Chart 6 — Trk/Line Data

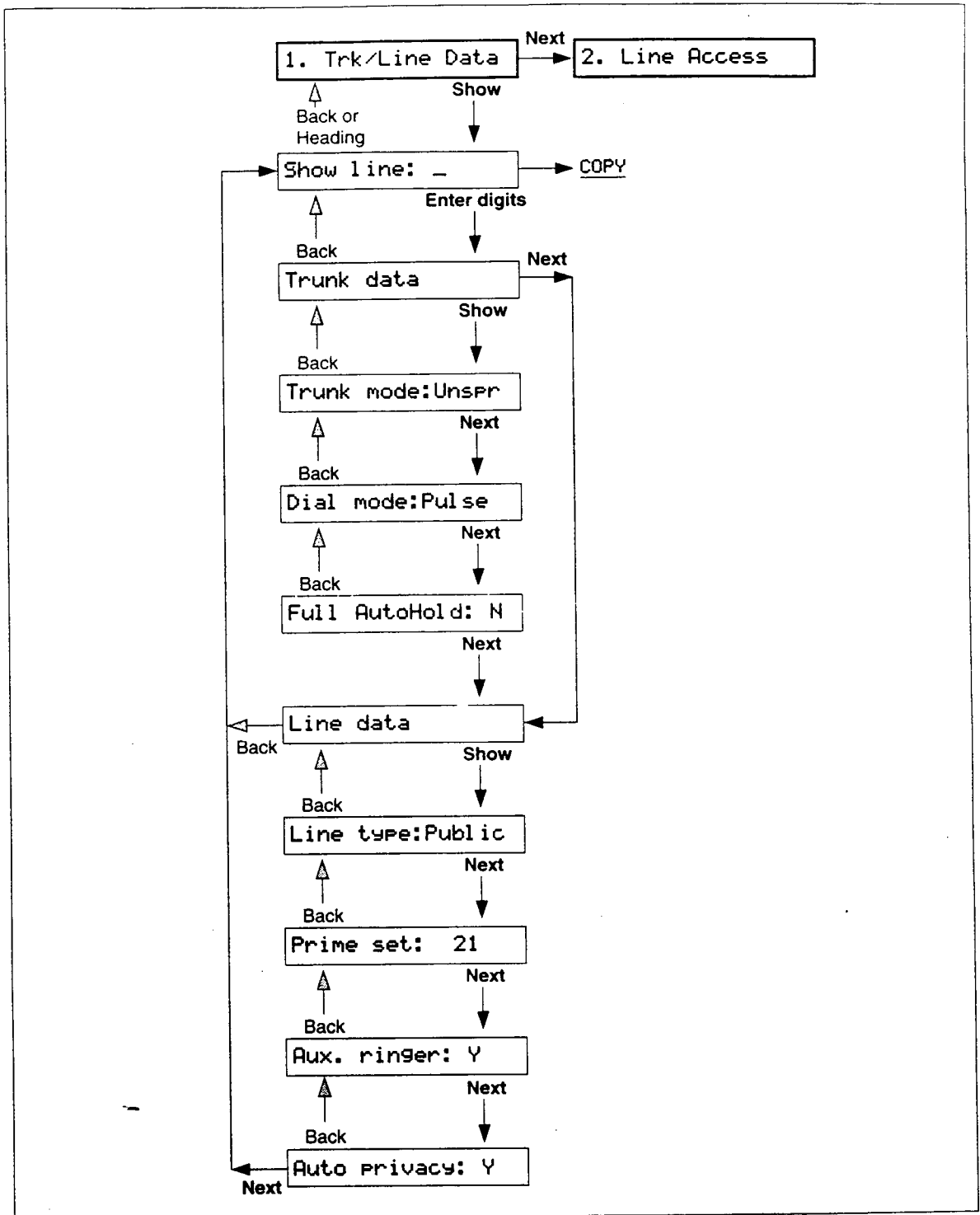

Line Access

Use 2. Line Access to program characteristics for each telephone. These characteristics establish which lines the telephone may use.

When you are finished programming the Line Access settings for a telephone, you may copy those settings to another telephone by using the COPY display button (or on the M7208 Telephone) at the `Show set: _` prompt.

Entering the telephone to be programmed

Enter any available DN. Default DNs range from 21 to 36. DNs can be later changed to a new number in 5. System Data of Configuration programming.

Note: Settings are automatically applied for the Analog Terminal Adapter (ATA) if installed. See the *ATA Installation Guide* for the defaults.

Line assignment

Add or remove lines to assign one or more lines to each telephone. The default line assignments to each telephone are Line 01 and Line 02.

- A Private line can only be assigned to one telephone. (It is also automatically assigned to the Prime Telephone for that line.)
- If you assigned the PBX template in System Startup, a Line Pool is assigned to the telephone instead of external lines. You can add lines if you wish. This would allow the telephone to ring for incoming external calls.
- If a line is assigned to a Line Pool, but is not assigned to any telephone, that line can only be used to make outgoing calls.

Answer DNs

Up to four buttons on a telephone can be programmed for answering calls to the DNs of other telephones. The default is No Answer DNs.

Ringling

For each line and Answer DN assigned to a telephone, you can determine whether incoming calls will ring at the telephone. Possible settings are Ring and No Ring. The default setting is Ring.

Line pool access

You can determine which Line Pool each telephone has access to. Possible settings are Yes and No. The default setting is No for each of the three line pools, which means no telephone has default access to Line pools.

- Assigning a Line Pool to a telephone saves on the number of buttons required for external lines on the telephone.

Intercom buttons

You can determine the number of Intercom buttons on the telephone. Possible settings are 0, 1, or 2. The default setting is 2.

- A minimum of two Intercom buttons are required for conferencing with two other Norstar telephones in the same system.
 - A minimum of one Intercom button is required if internal calls are to be made or received from the telephone or Line Pools are to be accessed from the telephone.
-

Prime line

You can assign the Prime line for each telephone. The Prime line is the first line to be automatically provided at a telephone when you make a call. The appropriate Prime line will depend on the customer's requirements. The default setting is None, which means that no Prime line is assigned to the telephone. Other possible settings are an external line (Line number), Line Pool A, Line Pool B, Line Pool C or intercom (I/C).

- A Prime line is not related to the operation of a Prime telephone.

Chart 7 — Line Access

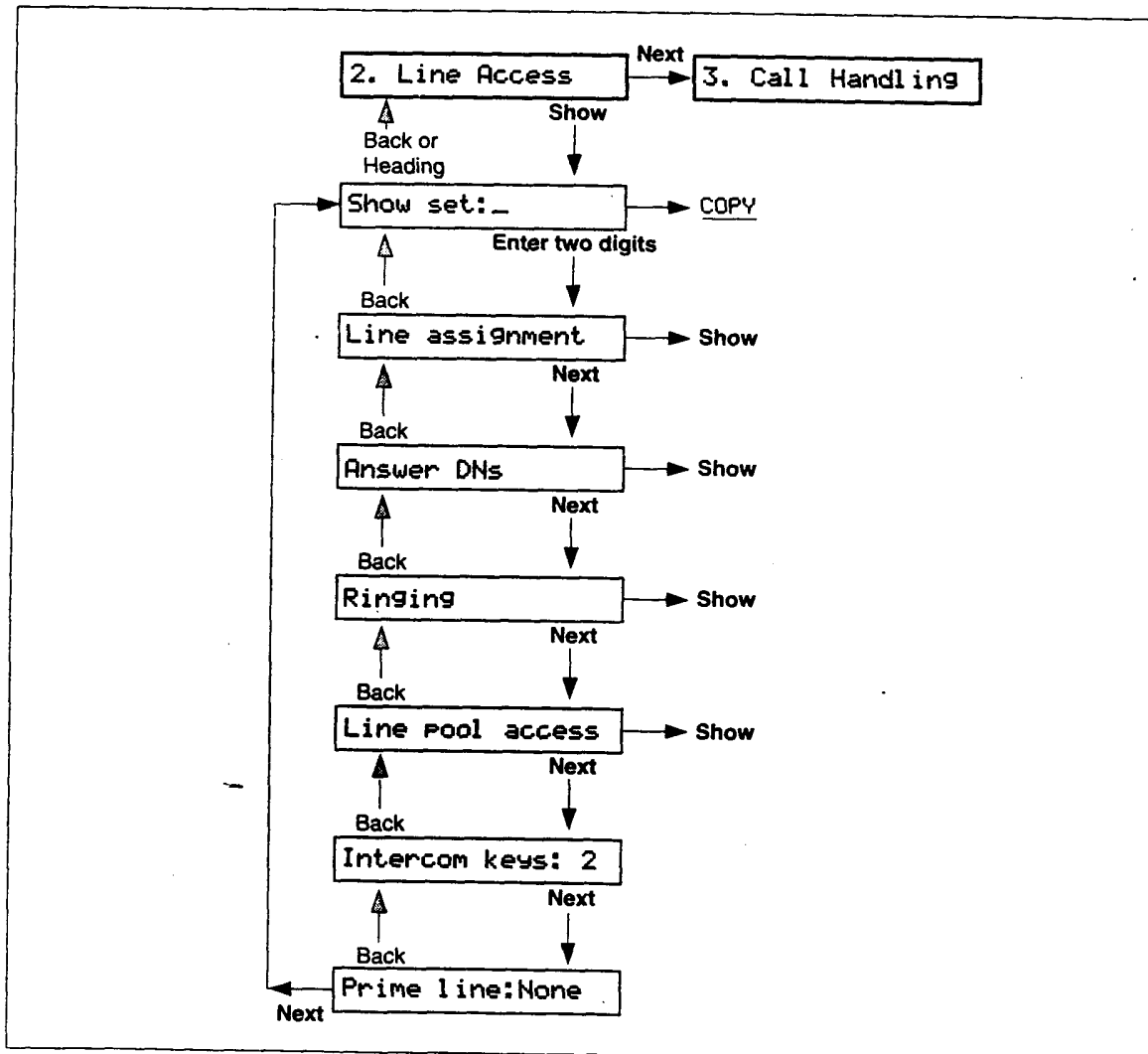

Call Handling

Use 3. Call Handling parameters to program system-wide characteristics for certain call features. These characteristics are not associated in programming with any particular line or telephone.

Held reminder

Choose if the Held Line Reminder feature is to be active for all external lines. Possible settings are Yes and No. The default setting is No. If Yes, the programming menu takes you to the Remind delay setting.

Remind delay

Assign the delay (in seconds) before the Held Line Reminder feature begins at the telephone which has put an external line on hold. Possible delays are 30, 60, 90, 120, 150 and 180 seconds. The default delay is 60 seconds.

- This setting does not appear if Held Line Reminder is not active.

DRT to prime

Choose if the Delayed Ring Transfer to Prime telephone feature is to be active for all external lines associated with the Prime telephone. Possible settings are Yes and No. The default setting is Yes. If Yes, the programming menu takes you to the DRT delay setting.

- Ensure that you have an operational Prime telephone.
- This setting applies only to external lines with an assigned Prime telephone.

DRT delay

Assign the delay (number of rings) before an unanswered external call is redirected to the Prime telephone. Possible delays are 1, 2, 3, 4, 6 or 10 rings. The default delay is 3 rings.

- To estimate the delay time in seconds, multiply the number of rings by six.
- This setting does not appear if DRT to prime is not active.

Transfer callback

Choose the delay (number of rings) before a transferred external call will callback to the originating telephone. The possible delay is 3, 4, 5, 6, or 12 rings. The default delay is 3 rings.

- To estimate the delay time in seconds, multiply the number of rings by six.

Park prefix

Park prefix assigns a one digit code to retrieve a parked call. Any valid digit from 0 to 9, or None, can be assigned. The default Call Park prefix is 1. The Call Park prefix cannot be the same as the first digit of an internal DN, the first digit of a Line Pool access code, the Direct-Dial digit, or the External Line access code.

Park timeout

Assign the number of seconds before a parked external call will callback to the originating telephone. The possible timeout is 30, 45, 60, 90, 120, 150, 180, 300, or 600 seconds. The default timeout is 45 seconds.

Camp timeout

Assign the length of delay before a camped call is returned to the telephone which camped the call. The possible timeout is 30, 45, 60, 90, 120, 150, or 180 seconds. The default timeout is 45 seconds.

Directed pickup

Select Yes (the default) to allow any telephone within the system to answer calls by specifying the ringing telephone's number (unlike Call Pickup Group which only allows pickup of calls within a specified group of telephones). The other possible setting is No.

On hold

Choose what a caller will hear on an external line when the line has been put on hold. Possible settings are Tones, Music, or Silence. The default setting is Tones.

- A customer supplied music source must be connected in

Chart 8 — Call Handling

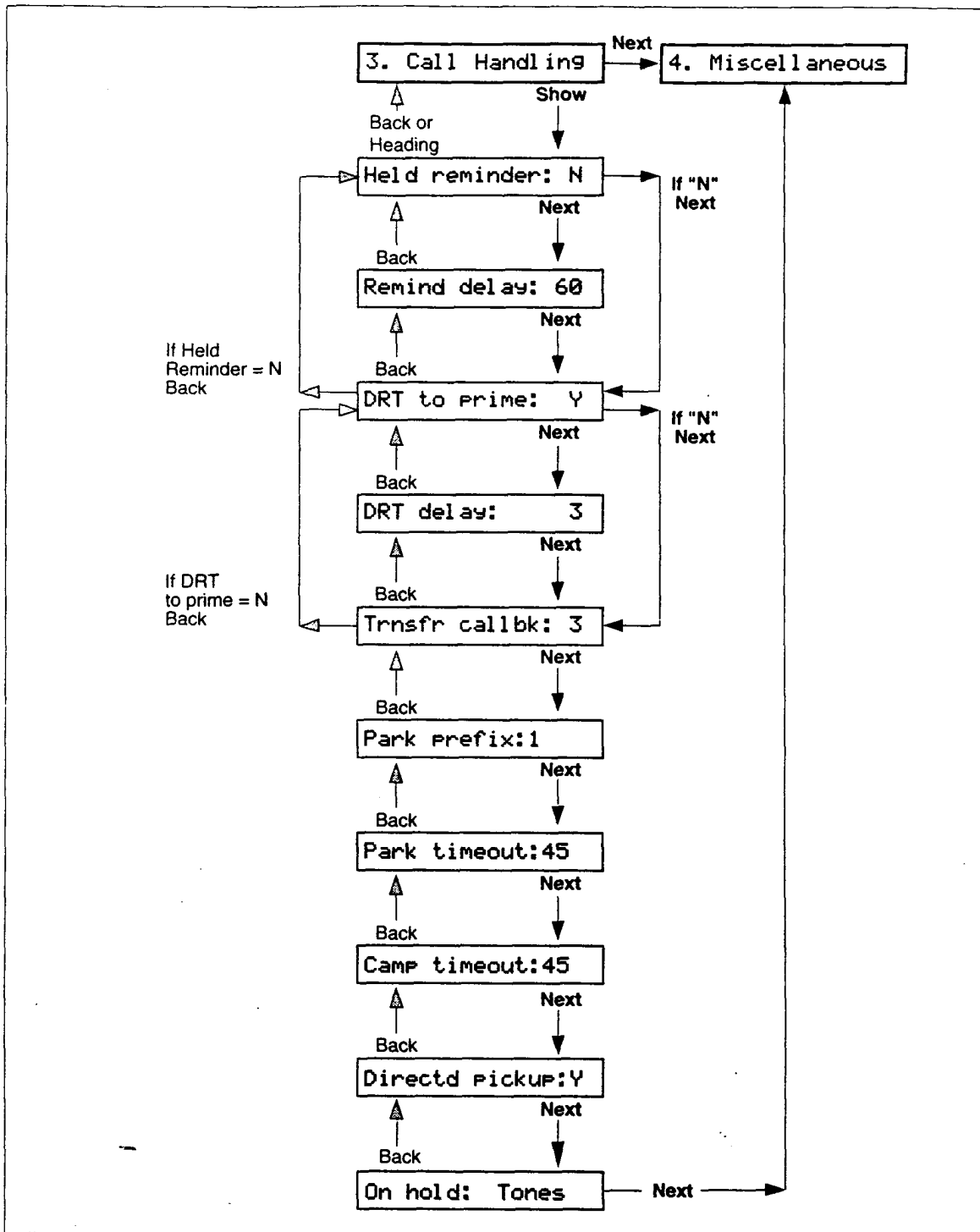

Miscellaneous

Use 4.Miscellaneous settings to program various system-wide characteristics. These characteristics are not associated in programming with any particular line or telephone.

Background Music

Choose if the Background music feature is to be available with the Norstar system. Possible settings are Yes and No. The default setting is No.

- If this feature is enabled, ensure that an external music source has been connected to the KSU. (This music source is also used for the Music on Hold feature.)

Direct-Dial digit

Choose the digit you dial in order to get the Direct-Dial Telephone to ring. The possible settings are any valid digit from 0 to 9, or None. The default setting is the digit zero. The Direct-Dial digit cannot be the same as the first digit of an internal DN, the first digit of a Line Pool access code, the External Line access code, or the Call Park prefix.

Link time

Assign the Link time (in milliseconds). Possible times are 100, 200, 300, 400, 500, 600, 700, 800, 900, 1000 milliseconds. The default Link time is 600 milliseconds.

- The Link time depends on the requirements of the host PBX, Centrex, or other switching system that must be accessed by Norstar.
- Link is another name for Recall or Flash.

Telephone relocation

Choose if the Set Relocation feature is to be active. Possible settings are Yes and No. The default setting is No.

- It is advisable to turn Set Relocation on after the telephone installation and programming has been done. This provides you with more flexibility in testing equipment. If this feature is disabled, and a telephone is moved, that telephone's internal number and Administration data remain with the physical port.

- If new telephones are being installed at the same time that other telephones are being relocated, you should perform the following procedure to ensure that Set Relocation occurs:
 1. Select Yes to turn on Set Relocation.
 2. Unplug the telephone that is to be relocated.
 3. Plug the telephone into its new location.
 4. Plug a new telephone into the old location of the telephone that was moved.

Host delay

Host delay programs the delay in milliseconds between the selection of an outgoing line and the moment that Norstar sends dialed digits or codes on that line. Possible delays are 200, 400, 600, 800, 1000, 1200, 1400, 1600, 1800 or 2000 milliseconds. The default is 1000 milliseconds.

Disconnect Supervision delay

Disconnect Supervision delay allows you to specify the duration of an Open Switch Interval (OSI) before the Disconnect (or loop) Supervision feature disconnects a call on a supervised external line. Possible settings are 60, 100, 260, 460, or 600 milliseconds. The default is 460.

- Disconnect Supervision is assigned to each line with the Trunk mode setting in the Trunk data section of Configuration programming.

External code

The External code allows an M7100 Telephone or an ATA to access external lines. Any valid digit from 0 to 9, or none, can be assigned. The default is 9. The External Line access code cannot be the same as the Call Park prefix, the Direct-Dial digit, the first digit of a Line Pool access code, or the first digit of an internal DN.

Line pool codes

Line Pool access codes are used to specify the line pool you wish to use for making an outgoing external call. Assign Line Pool access codes for each of the three possible Line Pools. The possible settings are a one to four digit number or None. The default setting is none.

- A Line Pool access code cannot start with the first digit of an internal DN, the Direct-Dial digit, or the Call Park prefix.
- A Line Pool access code takes precedence over the External Line access code if there is a conflict.
- Line Pool access codes starting with the same number must be the same length.
- Ensure that the System Coordinator knows the codes.

Installer password

This allows you to change the Installer password for access to Configuration programming. The possible setting is any combination of one to six digits. The default Installer password is

2 6 6 3 4 4 which is the same as C O N F I G .

- The default password is required to first gain access to Configuration programming. However, it is advisable to change that password to a new one.
 - Remember to record the new Installer password in the *Compact DR5 Programming Record*.
 - It is easier to remember the password if the digits spell a word.
-

Chart 9 — Miscellaneous

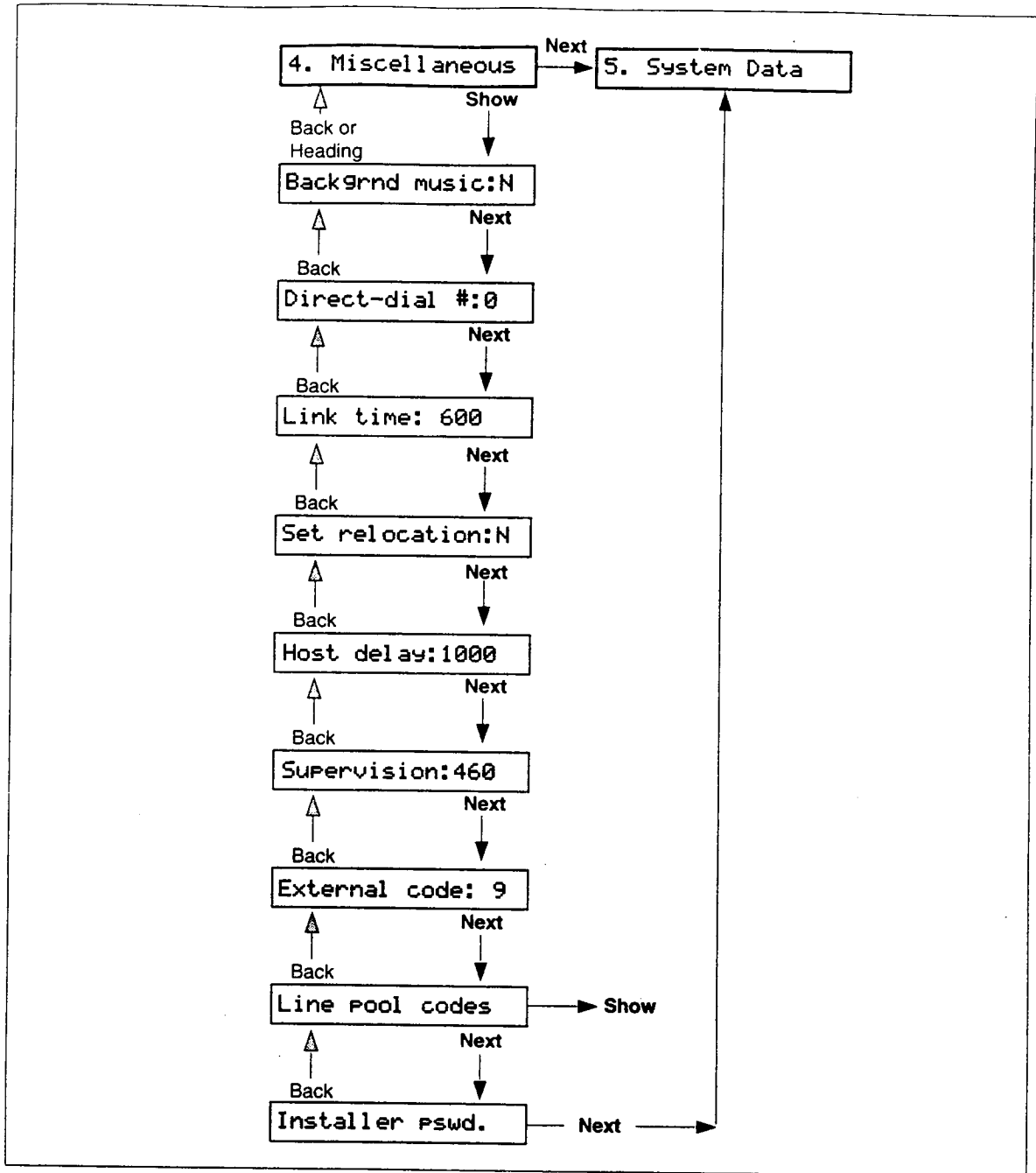

System Data

Use 5. *System Data* to change the internal number or Directory Number (DN) of an individual telephone.

Note: Do not attempt internal number changes within two minutes of System Startup or you may disable the ports.

Individual DNs

Enter the appropriate internal number when you are prompted for the old and the new internal number. A message will appear on the display if either internal number is invalid. The possible settings are any valid internal number between 20 and 99. The default internal numbers for telephones range from 21 to 36.

- No internal number changes occur until the Configuration session ends. (Press the button.)
- There can be only one telephone for each internal number.
- If the "new internal number" already existed for another telephone, that telephone will be given the "old internal number".
- The first digit of an internal number cannot be the same as the External Line access code, the Direct-Dial digit, the Call Park prefix, or the first digit of a Line Pool access code.

Chart 10 — System Data

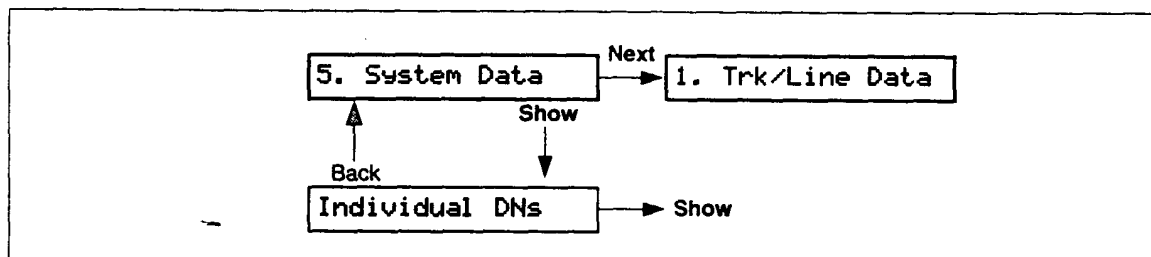

Note: If you change a DN, you cannot continue programming in any of the other sections while in the same Configuration session. Press the button to end the session.

Set Copy

Use **C. Set copy** for copying programmed data from one telephone to another. You can copy System data only or you can copy both System data and Personal programming (User data). System data is programmed in Configuration and Administration. Personal programming is performed by the user at the individual telephone, and allows the telephone to be customized according to the user's requirements.

Set Copy Options

COPY:SYSTEM data

When this message appears on the display, you can choose to copy System data pertaining specifically to telephones.

COPY:SYSTEM+USER

When this message appears on the display, you can choose to copy System data and Personal programming. Both telephones must be the same model and connected to the system before this option can be used.

Note: Do not confuse **C. Set copy** with the **COPY** display button (or **Copy** on the M7208 Telephone), which is for selective copying of specific groups of settings from one telephone or external line to another.

Telephone settings which CANNOT be copied

System settings in Configuration programming

1. Trk/line Data
 - Private line appearances
 - Prime telephone designation for a line
5. System Data
 - Directory Number (DN)

System settings in Administration programming

2. Names
 - Telephone name
4. Direct-Dial
 - Direct-Dial telephone designation
6. Service Modes
 - Extra-Dial telephone designation
 - Control telephone designation for a line
 - Service mode Ringing telephone designation for a line
9. Call Services
 - Auto Call Info telephone designation for a line
 - Log space

Personal programming

- Autobump
 - Autolog options
 - Contrast Adjustment
 - Dialing modes (Automatic Dial, Pre-Dial, Standard Dial)
 - Log password
 - Ring Type
 - Ring Volume
-

Telephone settings which CAN be copied

Listed below are the telephone related settings which can be copied to a destination telephone, overriding any previous programming.

System settings in Configuration programming

2. Line Access

- Line assignment
- Answer DN
- Ringing line preference
- Line pool access
- Number of Intercom buttons
- Prime line designation

System settings in Administration programming

5. Capabilities

- Set Filter
- Line/set filters
- Set Lock
- Full handsfree
- Auto handsfree
- Handsfree answerback
- Pickup group
- Paging
- Page zone
- Auxiliary ringer
- Direct-Dial
- Forward on busy
- Forward on no answer
- Forward no answer delay

- Allow redirect
- Redirect ring
- Receive tones
- Hotline
- Priority call

9. Call Services

- Logging set designation
- Show external Voice Message
- First display

Personal programming

If desired, the following Personal settings can be copied along with the System data:

- Programmable button assignments (Internal Autodial, External Autodial, and feature access)
- Language choice
- Personal Speed Dial entries

Entering Set Copy

You can only enter Set Copy through Configuration programming with the Installer password.

After A. Configuration appears on the display:

1. Press twice.
The display shows C. Set copy.
2. Press to go to COPY:SYSTEM data.

Chart 11 — Set Copy

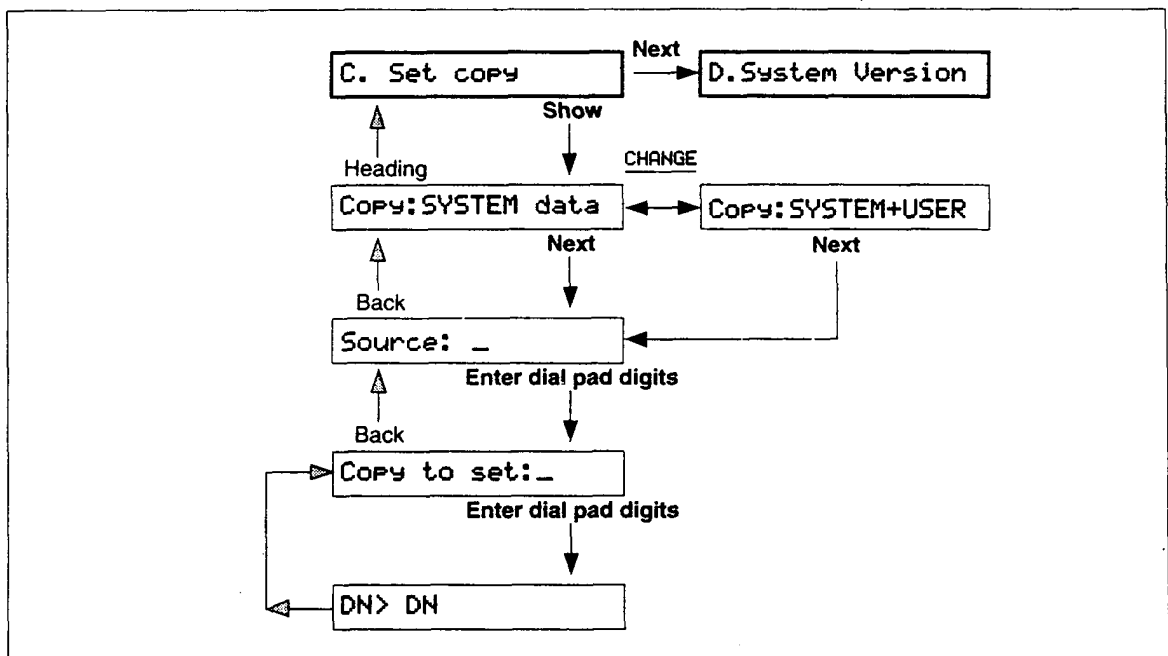

System Version

System Processor (SP) version numbers can be used to determine whether you have the latest software release, and to trace a software fault if one occurs. For instance:

- SP version numbers can indicate a Software Cartridge incompatibility.
- SP and telephone version numbers can indicate a telephone version incompatibility.
- SP and functional terminal version numbers can indicate a functional terminal incompatibility.

Entering System version

You can only enter System Version through Configuration programming with the Installer password.

After **A. Configuration** appears on the display:

1. Press three times.
The display shows **D. System Version**.
 2. Press .
- The display shows the version number of the SP.

Chart 12 — System Version

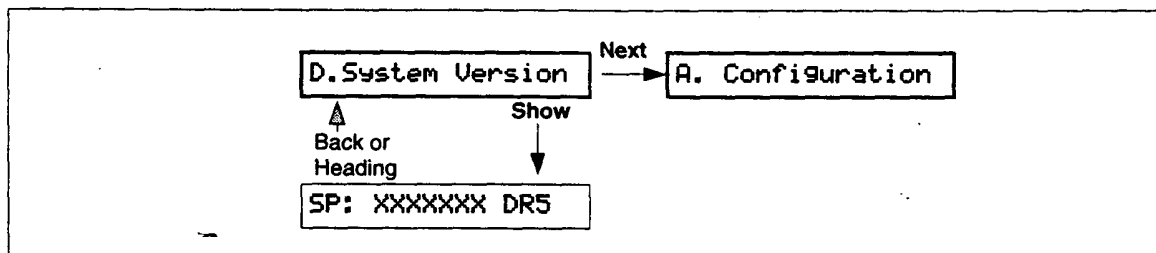

Troubleshooting

Testing the lines and telephones

1. Check all external lines by selecting each line in turn at one of the telephones and verifying the dial tone. If you do not get dial tone, plug a single-line telephone directly into the external line at the distribution panel. If you still do not get dial tone, check all your wiring or contact your telephone company.
2. Check all internal connections by calling each Norstar telephone from another Norstar telephone.
3. Check the quality and clarity of all connections. Check for crackling, static, hums, or any other unusual noise.
4. If there are any problems, refer to other procedures in this chapter.
5. Verify the visual indicators:
 - Select a line or Intercom button. The ► indicator beside that button should appear.
 - Press * .The display should show **Button Inquiry** followed by **Press a button**. Press the button to exit from this feature.

Analog Terminal Adapter (ATA) trouble

1. Check the single-line telephone connection by using an installer's test telephone.
2. Check the connections to the jack.
3. Check the connections to the ATA.
4. Disconnect the ATA and replace it with a working Norstar telephone. If the telephone works properly, this verifies that the KSU is working properly.
5. Verify that programming has been done as described in the *Norstar Analog Terminal Adapter Installation Card*.
6. If the trouble seems to be in the KSU, double check all wiring and programming options. If this does not help, refer to the **KSU down** section of Troubleshooting.

WARNING

This unit must be powered from a Class 2 power source that is UL and CSA listed.

Auxiliary Ringer trouble

1. If the Auxiliary Ringer is used for Service Modes, ensure that Service Modes is activated from the Control Telephone.
2. Check the wiring between the Auxiliary Ringer generator and the ringing device. (See Chart 2 — Internal Wiring.)
3. Check the wiring between the Auxiliary Ringer and the distribution panel.
4. Check the Auxiliary Ringer contact operation with an ohmmeter across the pins.
5. Check that the Auxiliary Ringer is programmed to ring for any of the following programmable settings:

Feature	Programmed in:
Aux. Ringer for a specific line	A. Configuration (1. Trk/Line Data)
Aux. Ringer for a specific telephone	B. General admin (5. Capabilities)
Aux. Ringer for a specific Service Mode	B. General admin (6. Service Modes)

Call Identification Interface

1. Use the Call Information feature on an incoming call to verify the operation of the CII.
2. Check the connections to the CII. Refer to the *CII Installer Card* for installation details.
3. Verify that the programming has been done as described in the *Compact DR5 Programming Record* and the *Compact DR5 System Coordinator Guide*.
4. Verify that you are subscribing to visual call Display services from your local telephone company.
5. Replace the CII.

Dial tone absent (on external lines)

1. Use Button Inquiry (*) to check the programming of a memory button that you think is assigned as an external line.
2. Check for dial tone by using an installer's test telephone at the connections for the external line on the distribution block.
3. Check the connections between the KSU and the distribution block.

External Paging trouble

1. Ensure that you are using the proper feature code (Feature 6 2).
2. Check the wiring between the 50-pin connector and the paging amplifier.
3. Check the wiring between the connections. (See Chart 2 — Internal Wiring.)
4. Check that the paging equipment is operational and that the output from the Norstar KSU is 775 mVrms across 600 Ω .

Hung lines at a telephone

Line indicators that have been solid for a long time are the only visible indication that lines are hung.

A line that has been redirected using Line Redirection may, under some circumstances, remain busy after a call is over. If this happens, the outgoing line for the redirection also remains busy. You can clear this kind of hung line only at the telephone that was used to redirect the line.

1. Select Button Inquiry (Feature * 0) at the telephone that was used to redirect the line.
2. Press the button of the redirected line.
3. Press SHOW or #.
4. Press DROP or *.

Both the redirected line and the outgoing line for the redirection should now be cleared.

KSU down

1. Check that the ac power cord is properly connected.
2. Check that the Software Cartridge is firmly seated in its slot.

CAUTION

Do not install or remove the Software Cartridge when KSU power is on.

3. If ac power is present and the LED indicator on the KSU is off, replace the KSU.

Music on Hold/Background Music trouble

1. Ensure that the volume control (*) is turned up and you are using the Background Music feature code ().
2. Check the applicable Configuration programming settings to ensure that the feature is enabled:

Feature	Programmed in:
Music on Hold	3. Call handling
Background Music	4. Miscellaneous

3. Check the wiring between the music source and the 50-pin connector.
4. Check the polarity of the connections between the music source and the distribution block.
5. Ensure that the music source is turned on, is operational, and has the volume control properly adjusted.

Telephone dead

1. Check for dial tone.
2. Check the receiver cord connection.
3. Check the display. If the display is unreadable, ensure that the display contrast adjustment (*) is appropriate.
4. Check the internal wiring at both the modular jack and the distribution block.
5. Check the internal line.
6. If the problem persists, replace the telephone with a known working Norstar telephone.

Note: An internal line should have between 15 and 20 Vdc across the Tip and Ring when the telephone is disconnected.

Finishing up

If you are required to continue programming, refer to the *Compact DR5 System Coordinator Guide*.

If you are not required to continue programming, give the System Coordinator the *Compact DR5 Programming Record*.

Applying the button labels

If you perform all of the programming for a system, apply the appropriate button labels on the telephones. Before you apply button labels, activate the Button Inquiry feature (*) to avoid activating features as you put the labels onto the buttons.

For the customer

Remember to leave the following items at the installation site:

For the System Coordinator

- *Compact DR5 System Coordinator Guide* (with the Programming Overlays)
- *Compact DR5 Programming Record*
- Optional equipment User Cards (for example, the BLF and ATA)
- Spare button labels and button caps
- Telephone User Cards (for the M7100, M7208, M7310, and M7324 as required)
- *Compact DR5 Telephone Feature cards*
- *Compact DR5 Prime Telephone card*

In the KSU pocket

- *Compact DR5 Installer Guide* (with the Programming Overlays)
- Optional equipment Installation Cards (for example, the BLF and ATA)

Personal programming

Information on telephone feature programming and operation can be found in the *Compact DR5 System Coordinator Guide*.

Call Display services

Your Norstar system can access information contained in Call Display services offered by your public telephone company, and uses that information to provide additional messaging tools to the Norstar user.

Note: You can access Call Display information only if you subscribe to the services, and if you have Call Identification Interface hardware installed. Contact your Customer Service representative for more information.

Call Display information may be shown on your telephone display when a call is alerting, identifying the caller to you. Specific telephones are programmed to receive this information in Administration programming. For more information see the Call Information section in the Programming chapter of the *Compact DR5 System Coordinator Guide*.



**Compact DR5 (with Disconnect
Supervision) System
Coordinator Guide**

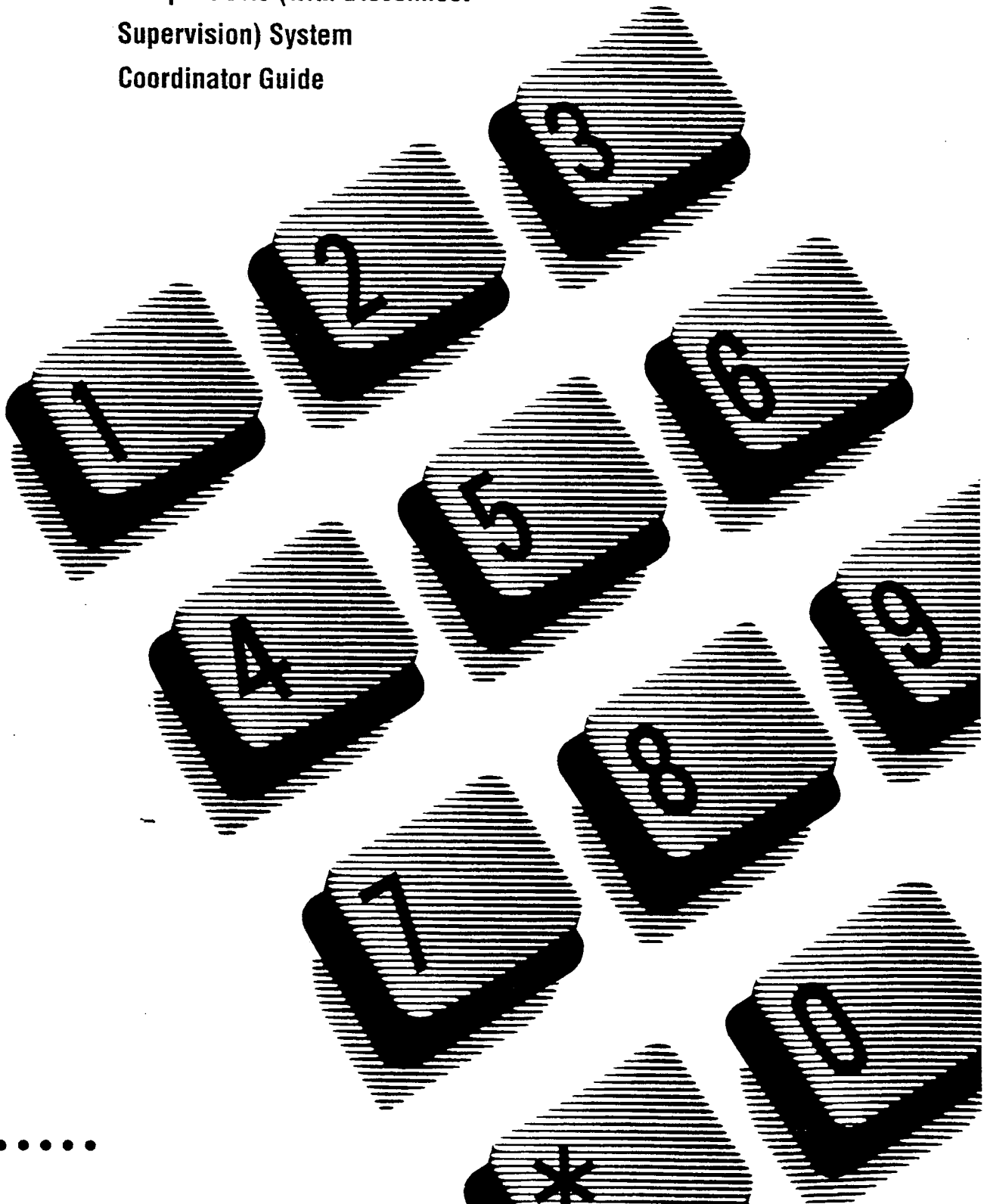

Contents

Welcome to Norstar 1-1

- System Coordinator's role 1-1
 - Assisting your co-workers 1-2
 - Your Customer Service representative 1-2
 - Call Display services 1-3
 - Call Display Information 1-3
 - Call Log 1-6
 - Message Waiting 1-11
-

Programming 2-1

- How to do programming 2-1
 - Planning 2-1
 - Programming tools 2-3
 - Using the Overlay 2-4
 - The Norstar display buttons 2-6
 - Programming details 2-7
 - Administration overview 2-9
 - Administration headings 2-9
 - Entering Administration 2-11
 - Exiting Administration 2-11
 - Moving through Administration 2-12
 - System Speed Dial 2-13
 - Names 2-17
 - Time and date 2-20
 - Direct-Dial 2-23
 - Capabilities 2-24
 - Dialing Filters 2-24
 - Telephone (Set) abilities 2-28
 - Line abilities 2-34
 - Class of Service (COS) passwords 2-34
 - Service Modes 2-37
 - Password 2-41
 - Log Defaults 2-42
 - Call Services 2-43
 - Auto Call Info 2-43
 - Telephone (Set) Services 2-44
 - Voice Message Center telephone numbers 2-45
 - Voice Message Center lines 2-45
-

- Copying settings 2-46
 - Line programming 2-46
 - Telephone programming 2-46
 - Capabilities programming 2-46
- Programming reminders 2-47
 - Norstar telephones 2-48
 - Prime telephone 2-49
 - Page zones 2-49
 - Line Pools 2-49
 - Miscellaneous programming 2-49
 - Control telephones 2-49
 - Service Modes 2-50
 - Call Pickup Groups 2-51
 - System Speed Dial 2-52

Telephone features 3-1

- Using Norstar features 3-2
- Answering the telephone 3-6
 - What line indicators mean 3-8
 - Rings you may hear 3-8
 - Prime telephone displays 3-11
- Autodial 3-13
- Call Forward 3-16
- Call Information 3-19
- Call Log 3-21
- Call Park 3-31
- Call Pickup 3-33
- Call Queuing 3-36
- Camp-On 3-37
- Conference 3-39
- GOS Password 3-44
- Customizing your telephone 3-45
- Dialing 3-52
- Do Not Disturb 3-58
- Feature programming 3-59
- Group Listen 3-62
- Handsfree/Mute 3-63
- Hold 3-65
- Host System Signaling 3-67
 - Host system signaling codes 3-67

- Line Pools 3-70
- Line Redirection 3-72
- Long Tones 3-77
- Messages 3-78
- Norstar Telephones 3-84
 - Buttons 3-84
 - Headset 3-86
 - Hearing aid compatibility 3-87
 - Wall mounting 3-87
- Page 3-88
- Priority Call 3-90
- Service Modes 3-92
- Special Telephones 3-94
- Speed Dial 3-97
- System features 3-100
- Time features 3-105
- Transfer 3-106
- Voice Call 3-111

User cards 4-1

Glossary 5-1

Index 6-1

Welcome to Norstar

In addition to basic telephone service, your Norstar digital key system has many extra features that will greatly improve your office communications.

Please take the time to read this Guide. It will help you to learn the various tasks which a System Coordinator should perform. This guide also serves as a reference when you assist co-workers to become familiar with Norstar features.

When a telephone system is first installed, it takes a bit of time to settle into using new equipment. Norstar minimizes this orientation by providing straightforward features and simple instructions.

System Coordinator's role

The System Coordinator plays an important role in customizing Norstar to suit the organization and updating information as the office grows and changes.

Norstar can be customized at three levels:

Personal programming

Personal programming is done by individual telephone users who wish to personalize their Norstar telephones by programming features and telephone numbers onto specific memory buttons.

Administration programming

Administration programming is done by the System Coordinator, when you want to change various system-wide settings, as well as some specific settings for each line or telephone.

Configuration programming

Configuration programming is usually done for you by the Installer or Customer Service representative when Norstar is being installed. Specific system-wide parameters are set up in Configuration.

Assisting your co-workers

It is human nature to ask someone how to do something rather than read a user guide. The System Coordinator may be asked to demonstrate to co-workers how to select and use Norstar features. To help you prepare for that possibility:

- Familiarize yourself with the procedures for using Norstar features. Examine the components of your Norstar system, identifying the buttons on the different types of Norstar telephones. Read the Telephone User Cards chapter of this Guide for more information on each telephone.
- Familiarize yourself with the various programming reminders provided at the end of the Programming chapter of this Guide. Distribute copies of these reminders to your co-workers after filling in information such as Call Pickup group numbers and members.

It is important for everyone in the office to know that you are the System Coordinator and to know when you are available for consultation. You may wish to schedule sessions for small groups or provide individual assistance to co-workers for programming features on their Norstar telephones.

Your Customer Service representative

Ask your Customer Service representative for the service department's telephone number, and write it down. If you have problems with your Norstar equipment, telephone your Customer Service representative. If you have problems with programming or using any of the features, first read the appropriate section of this Guide and try again before calling your Customer Service representative.

Call Display services

Some public telephone companies offer Call Display services which provide information about an incoming call. The caller's name, telephone number and in some cases, long distance indication, can be shown on a telephone with a display. Your Norstar DR5 system uses this information so that you can:

- view incoming call information as well as the Norstar line name that receives the call,
- keep a log of incoming call information and,
- view an integrated display that appears when you have received a message from either an internal Norstar user or a Voice Mail message from an external caller.

Note: You can access Call Display information only if you subscribe to the services offered by your public telephone company, and if you have the appropriate hardware installed. Contact your Customer Service representative for more information.

Call Display Information

Call Display information may be shown on your telephone display when you answer an incoming call. In addition to the caller's name, telephone number and long distance indicator, if available, your Norstar system can display the name of the line that received the call.

In the case where several users share a line, only one telephone can be designated to automatically receive Call Display information when a call is alerting on that line. If the call is transferred or camped to another telephone, the Call Display information is automatically available to that telephone.

If a line is not administered to automatically deliver Call Display information to a telephone, the user can invoke the Call Information feature (see Telephone features chapter) or answer the call to view the information.

Depending on your requirements, Call Display information presents several convenient options.

- When a caller is identified before the call is answered, you can answer using a personal greeting. You can also prepare yourself prior to answering the call by retrieving any relevant documents, or otherwise orienting yourself to the expected discussion.
- The Long Distance indicator alerts you that an incoming call is long distance and may therefore have higher priority.
- If you are unable to immediately attend to an incoming call, you can use the calling information to make a quick note.
- You can shorten the interruption time of a call from a recognized person. For instance, you can quickly answer the call and let the party know that you are busy but will return the call soon.
- A telephone can be programmed to first view either the caller's name or number or line name. For example, an attendant might wish to see the calling number and area code first in order to transfer the call according to sales region. The salesperson's telephone could display the caller's name first so they can answer with a personal greeting.

- Call Display information allows you to answer calls on a priority basis. For example:
 - If several calls are alerting at your telephone at the same time, you can request information about the calls to decide which one may be more important.
 - If you are already on a call, information about a second call starting to alert at your telephone can help you to decide whether to answer the second call or remain connected to the first call.
 - If you are in a meeting, the information associated with an incoming call can help you determine if the call is important enough to interrupt the meeting.
 - If you have several calls on hold and wish to identify the callers, you can view the Call Display information associated with each of the calls to help you determine which one you will respond to first.

Programming tips

In order for the designated telephone to automatically receive Call Display information, it must be programmed to ring for incoming calls on that line.

Before programming Call Display information you may wish to consider the following:

- which individual would benefit the most from automatically receiving Call Display information on an alerting line?
 - how are calls routed and what information is the most important to know before a call is answered? For instance, if certain lines are private to individuals, an attendant might wish to first view the line name to determine who the incoming call is for.
-

Call Log

The Norstar Call Log feature uses incoming Call Display information to make a record of call details for follow-up. Call Log also records several other useful facts such as the time and date of the log entry, the number of repeated calls by the same caller and which telephone answered the call if it was subsequently rerouted and handled by someone else in the Norstar system.

When the volume of incoming calls exceeds the ability of employees to handle all calls, or when staff are unavailable to answer calls, Call Log provides a convenient means of capturing information about missed calls.

When connected to a call that has Call Display information, the Logit feature of Call Log can be used to provide a quick and accurate means of recording the caller's information for future use (see the Telephone Features chapter for more information).

Programming tips

Call Log space can be assigned to individual telephones according to how much space you wish to allocate to each user.

In order to maximize the value of Call Logs and avoid confusion for the end user and their customers, it is important to consider the following when configuring Call Log:

- Application of Call Log

Does the user want to return customer calls, track the numbers of calls unanswered, keep a record of most commonly called numbers, etc.?

- Who is most interested in logging calls on a particular line?

For instance, dentists working in a clinic may have an individual line assigned to them but prefer that the receptionist handle all of the calls logged on their line.

We strongly recommend that you limit the number of users logging calls for the same line, as this would be confusing. For example, if two users are logging calls for the same line, they do not know who the call was originally intended for, nor are both Call Logs updated when one of the users returns a customer's call. Potentially a customer could be called back twice.

There are few situations where the same call needs to be logged at more than one set.

Recommended configuration 1

All lines appear at the Attendant Position. Incoming calls are first answered on the Attendant's set and then transferred to the required destination.

The Attendant wants to track all calls unanswered on the system, during working hours and after hours. All users want to capture in their Call Log, any calls which they did not answer at their set and be able to return those calls from the log.

The Attendant Position logs **No one answered** on all lines and the users log calls **Unanswered by me**. In this configuration the users will log calls transferred to them via intercom (I/C) from the attendant or another user, even though the administration setting is (**Logging set: N**). Thus the entries in their Call Log are specifically meant for them.

Call Logs with an Attendant Position

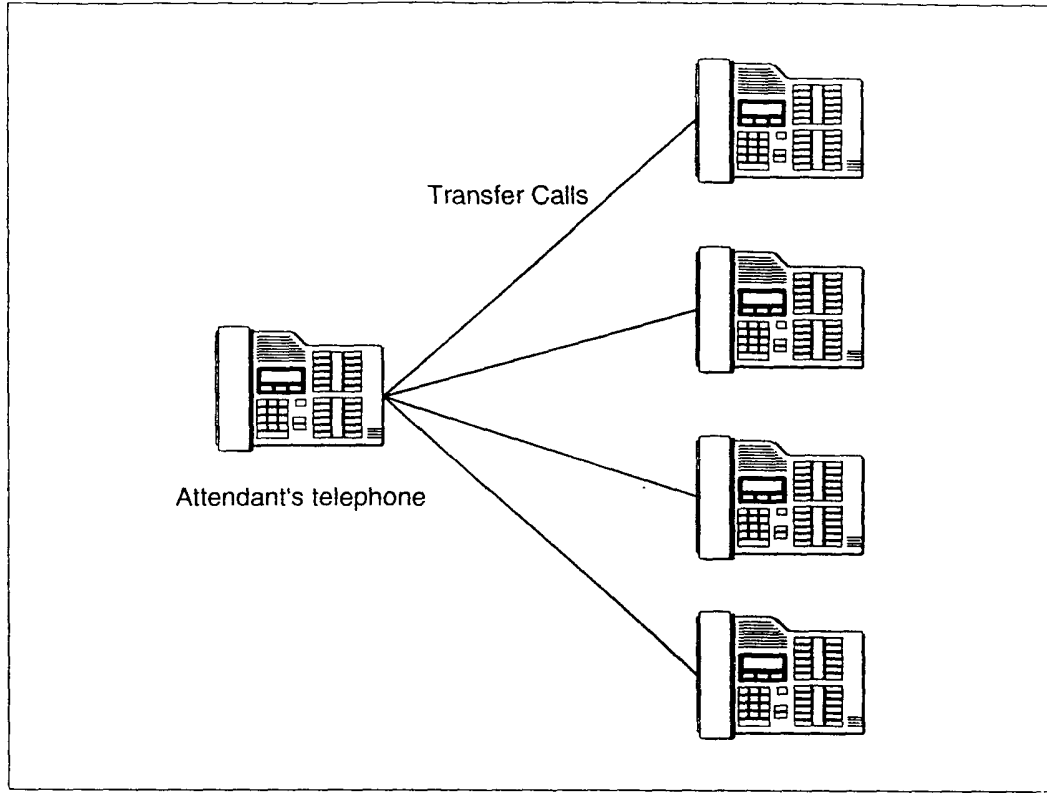

Programming:

Attendant Position

Configuration:

Line Access

Line assignment
(all lines to appear at the Attendant's set)

Ringing:
(Ring for all lines)

Administration:

Log Defaults

Space/Log: (assign log space to all sets, for example 10.)

Call Services

Set services
Logging set: Y
(for all lines)

Set Programming:

Feature * 8 4 (No one answered)

Set Users

Administration:

Set Programming:

Call Services

Set services
Logging set: N
(no lines assigned)

Feature * 8 4
(Unanswered by me)

Recommended configuration 2

Each Norstar user who will log calls has an individual line appearing at their set. The users have a variety of requirements in terms of logging calls. Using * 8 4 the users can program logging capabilities specifically for their sets.

Call Logs with individual lines

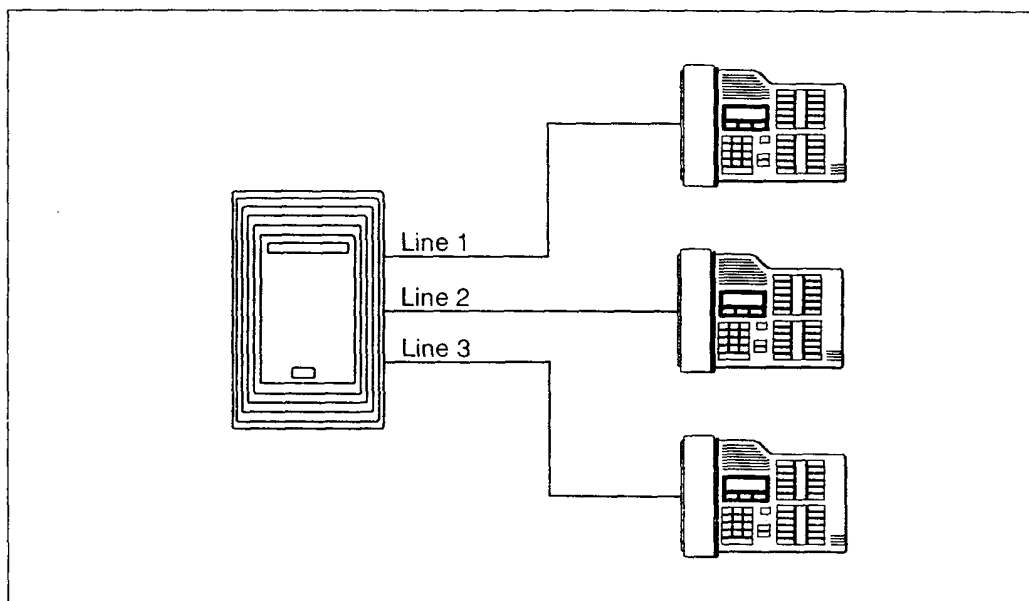

Programming:

Configuration:

Line Access

Line Assignment
(unique line at each set)

Ringin9:
(Ring9 for assigned line)

Administration:

Log Defaults

Space/Log: (assign log space to sets)

Call Services

Set services

Logging set: Y
(for assigned line)

Set Programming:

* 8 4 (No one answered, Unanswered by me, Log all calls, No autologging)

Recommended configuration 3

The Norstar system has lines 01 and 02 appearing on all sets. The supervisor wants to log all calls for lines 01 and 02 at his/her set in order to analyze call traffic. Two users have been selected to return unanswered customer calls. To avoid confusion when logging and sharing lines, one user logs **No one answered** calls on line 01 and a second user logs **No one answered** calls on line 02. This clearly identifies who is responsible for returning calls for each line and ensures that only one person calls the customer back.

Call Logs with shared lines

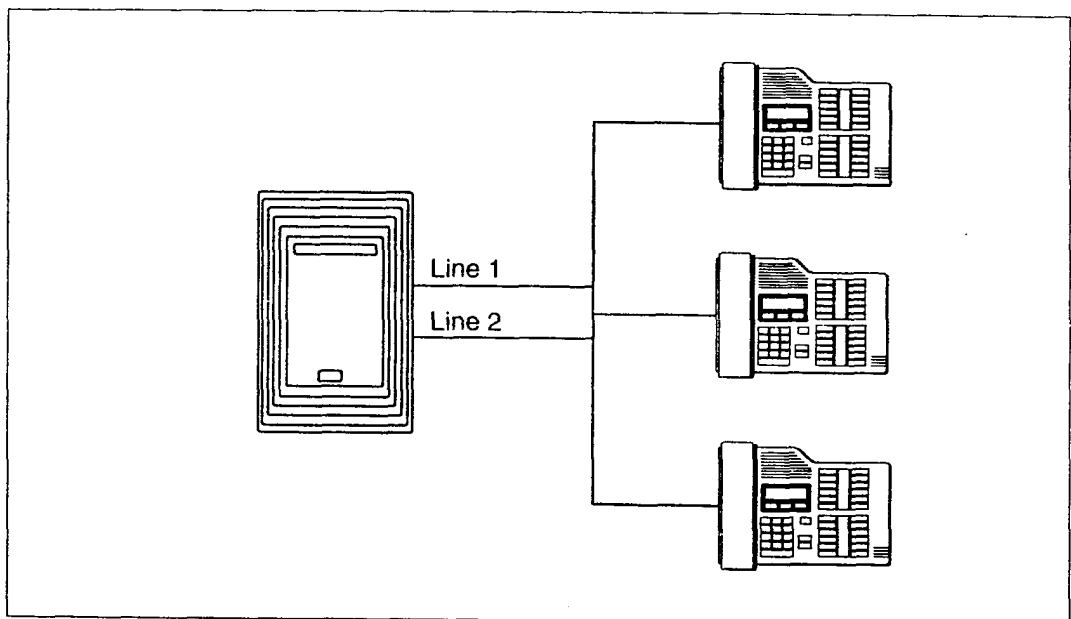

Programming:

Configuration:

Line Access

Line assignment
(lines 01 and 02 on all sets)

Ringing:
(Ring for lines 01 and 02)

Administration:

Log Defaults

Space/Log: (assign log space to sets)

Call Services

Set services

Show set: 21 (supervisor's)

Logging set: Y
(for lines 01 and 02)

Show set: 22

Logging set: Y (for line 01)

Show set: 23

Logging set: Y (for line 02)

Set programming:

Set 21 * 8 4 (Log all calls)

Set 22 and 23 * 8 4 (No one answered)

Note: For more information, see the *Call Log Feature Card*. This card is available in a separately orderable Call Display Key Cap Kit. Please contact your Customer Service representative.

Message Waiting

Norstar Message Waiting allows you to send and receive internal messages as well as maintain a record of your messages. If you have subscribed to Voice Mail Messaging (provided by your public telephone company), and visual message waiting indication is available, Message Waiting also informs you if you have messages at your Voice Message Center and allows you to:

- receive a visual indication that you have messages waiting,
- call your Voice Message Center to hear your messages and,
- clear the message waiting indication from your display.

Programming tips

In order for a telephone to use this feature, it must have a line appearance and Message Waiting must be activated for that line by your public telephone company.

It is possible for two or more telephones to share a line appearance. You must determine if one, some or all of the users sharing a line will receive Message Waiting notification. If it is a sub-group, such as a sales team within a company, it may be appropriate to share the feature providing that the users have an agreed upon procedure for retrieving and deleting messages.

For further information on Call Information, Call Log and Messages, see the Telephone features chapter. Programming actions are described in further detail in the Programming chapter.

Programming

The system comes programmed with default settings that may be sufficient initially. Administration programming is performed by the System Coordinator, and lets you change settings that probably have to be updated regularly because of staff turnover or new business contacts. You can also assign some features to individual lines and telephones. This provides you with real flexibility in making your telephones work together.

This chapter contains detailed procedures for programming System Speed Dial codes, Names for lines and telephones, and Time and Date information. If you are new to Administration programming, you may want to get comfortable with these three procedures before attempting other procedures.

Personal programming does not follow the same procedures as Administration programming. Personal programming allows you to assign a particular function to some of the keys, and is unique to each telephone. For more information on Personal programming, see the Feature programming description in the Telephone features chapter.

How to do programming

The system is programmed using an M7208, M7310 or M7324 Telephone. Use the buttons on the telephone to program a setting or to request a specific programming action.

Norstar guides you step-by-step on the telephone display while you enter programming, select and change what you want, and exit programming.

Planning

Only one Norstar telephone can access Administration programming at a time. While programming a telephone, you cannot use it to make or receive calls. While you are programming, other users of the Norstar system may use their telephones, but cannot program any memory keys.

Determine programming requirements

Read about the available programming settings in this chapter, then determine how your co-workers would like the features programmed.

Get the following information:

- the numbers of the installed lines,
- the internal telephone numbers of installed Norstar telephones,
- the telephone numbers to be programmed into System Speed Dial,
- the names for lines and telephones,
- the lines and internal numbers that are subject to Line abilities and Set abilities programming,
- the required Filters,
- the Set Abilities to be assigned to individual telephones,
- how the system should be programmed to optimize the Service Modes feature,
- whether a new Administration password is required, and
- whether Class of Service passwords are required.

Programming tools

A Norstar telephone

System programming can be performed on an M7208, M7310 or M7324 Telephone.

The Norstar Programming Overlay

The *Norstar Programming Overlay* is a paper cutout that labels telephone buttons used during programming. This makes it easier for you to recognize the button that you want.

The *Norstar Programming Overlay* for the M7208 Telephone is placed over all of the eight memory buttons. The Programming Overlay for the M7310 and M7324 Telephones is placed over the top four memory buttons with indicators. The *Norstar Programming Overlays* are provided at the end of this Guide.

The Compact DR5 Programming Record

The *Compact DR5 Programming Record* provides a convenient way to record what you have programmed. It also helps you to plan your programming. Settings are grouped according to their function.

Pages from the Record may be photocopied as necessary for programming many telephones or lines.

The Norstar Telephone User Cards

Each Norstar telephone has a *Norstar Telephone User Card* that lists the most commonly used features.

The Compact DR5 Telephone Feature Card

The *Compact DR5 Telephone Feature Card* lists the features that can be accessed with the button.

Using the Overlay

The indicators show which buttons can be used at a particular programming step. The functions on these buttons allow you to move through the headings and sub-headings of Norstar programming.

Heading

moves up in the hierarchy of headings and sub-headings.

Show

moves down in the hierarchy of headings and sub-headings, or to begin programming settings under a heading or sub-heading.

Next

moves to the next heading, sub-heading, or programmable setting.

Back

moves to the previous heading, sub-heading, or programmable setting.

Some of the functions identified on the Programming Overlay for the M7208 Telephone are available on display buttons on M7310 and M7324 Telephones. For information about the additional functions on the M7208 Telephone Overlay, see the section in this chapter entitled The Norstar display buttons.

Programming Overlay for the M7208 Telephone (top) and for the M7310 and M7324 Telephones (bottom)

		<input type="checkbox"/>	Copy Yes	M7208 Programming Overlay
		<input type="checkbox"/>	Backspace No	
		<input type="checkbox"/>	Change Remove	
		<input type="checkbox"/>	Add Default	
		<input type="checkbox"/>	Heading Retry	
		<input type="checkbox"/>	Show <--View-->	
		<input type="checkbox"/>	Back	
		<input type="checkbox"/>	Next OK	

Norstar Programming Overlay			
Heading	<input type="checkbox"/>	<input type="checkbox"/>	Show
Back	<input type="checkbox"/>	<input type="checkbox"/>	Next

The Norstar display buttons

If you are programming on an M7310 or M7324 Telephone you can perform many functions using display buttons. Depending on where you are in programming, one, two, or three display buttons may be available at any one time. Press one of the display buttons to select the function that you want.

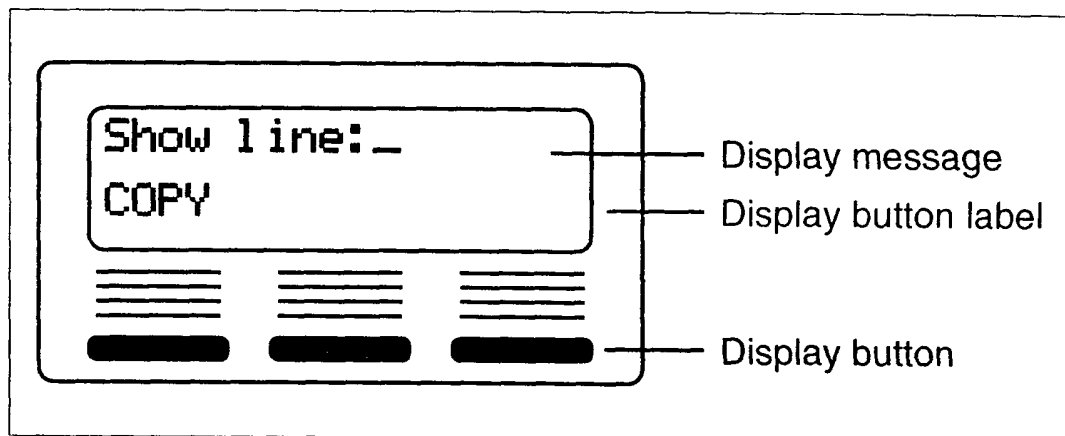

The most common display button labels are:

<u>CHANGE</u>	changes a programmable setting.
<u>BKSP</u>	moves the cursor one space backward (backspace) and deletes a character, allowing you to re-enter a number or letter.
<u>COPY</u>	copies line or telephone programming.
<u>VIEW→</u>	shows the last part of a displayed message longer than 16 characters.
<u>←VIEW</u>	shows the first part of a displayed message longer than 16 characters.
<u>--></u>	moves the cursor one position to the right when programming a name.
<u><--</u>	moves the cursor one position to the left when programming a name.

Programming instructions in this Guide refer to display buttons. If you are programming on an M7208 Telephone, use the M7208 Programming Overlay to select the button that corresponds to the referenced display button.

Programming details

Entering numbers

Numbers are entered from the Norstar telephone dial pad. The BKSP display button may be used to edit the number.

Line numbers must always be entered as a two-digit number with a leading zero. Internal telephone numbers, also referred to as Directory Numbers (DNs), are always two-digits long.

Viewing long telephone numbers

External telephone numbers can be up to 24 digits, but the telephone display is only 16 character spaces long. If you wish to see a previously programmed number that is longer than 16 digits, you must do the following:

Begin, for example, with **123456789012345...**

The display shows only the first 15 digits. The three dots (...) at the end of the display indicate that more digits remain to be displayed for the external number.

1. To see the remaining digits, press VIEW➔.
2. To see the first 15 digits again, press ←VIEW.

Entering names

Letters and numbers can be entered as part of a name for various settings. The method of entering a name is always the same.

Begin with a setting that prompts you to enter a name. The display shows a cursor (`_`) to indicate where you can enter the next character. To enter a name:

1. Press the button on the dial pad with the printed letter or number that you want.

Each time that you press the button, a new character is shown on the display. For example, the button for the number 3 has the letters D, E, and F, where:

D is shown after the first press

E is shown after the second press

F is shown after the third press

3 is shown after the fourth press

D is shown again after the fifth press.

(Letters are always shown in upper case.)

2. When the character that you want is displayed, press `-->` or `#` to move the cursor to the next character position.

OR

If you want to correct a character entered by mistake, press `<--` or `*` until the cursor is positioned beneath the character that you want to correct.

OR

If you want to move the cursor back and delete a character, press **BKSP**.

3. Repeat steps 1 and 2 for the remaining characters.

Administration overview

Administration programming lets you change settings for the entire Norstar system, as well as settings for individual telephones and external lines.

Pre-programmed default settings may initially be sufficient for your needs. You can use Administration programming to customize your Norstar system by changing these default settings. In this section, default options are shown in **bold** type.

The defaults correspond to those assigned during Norstar installation. The option you see while programming may be different if that setting has been changed. If the display shows a line number or internal number during programming, an example is shown in the Administration procedures.

Administration headings

Headings and sub-headings in Administration programming help you to keep track of where you are. An example of a heading is **1.Sys speed dial** for programming System Speed Dial. When you program a System Speed Dial number, **Display digits** is displayed as a sub-heading.

Administration programming has nine headings:

ADMINISTRATION CODE



Password:



1. Sys speed dial



2. Names



3. Time and date



4. Direct-Dial



5. Capabilities



6. Service Modes



7. Password



8. Log Defaults



9. Call Services

System Speed Dial assigns a two-digit code (01-70) for fast dialing of up to 70 telephone numbers from any Norstar telephone.

Names identifies external lines and telephones by name.

Time and Date adjusts the time and date displayed on each Norstar telephone.

Direct-Dial designates the telephone that can be reached by dialing a single digit.

Capabilities defines dialing filters, line abilities and telephone abilities. It assigns restrictions and capabilities to Class of Service (COS) passwords, to telephones, to lines and to line/telephone combinations.

Service Modes controls how the Norstar system responds to calls, depending on the time of day.

Password changes the password that controls access to Administration programming.

Log Defaults reallocates the Call Log space for all telephones in the system.

Call Services customizes the use of Call Display information for telephones.

Entering Administration

When your system is first installed, there is a default password stored in the Norstar system. Your Customer Service representative may change or clear the default password after installation. You are not prompted to enter a password as you enter Administration for the first time if your Customer Service representative has cleared the default password.

1. Release all calls on your telephone.
2. Enter the Administration access code:

Feature * * 2 3 6 4 6

which is the same as

Feature * * A D M I N .

3. If the display changes to **Password:**, enter the Administration password that is recorded on the *Compact DR5 Programming Record*. (The password is not shown on the display as you enter it.)

If the password is correct, the display shows

1. **Sys speed dial**, and three triangular indicators ► are shown on the vertical display.

OR

If the password is incorrect, the display does not change. Check the password. Press **RETRY** and re-enter the password.

4. Place the *Norstar Programming Overlay* over the buttons.

See the Password section in this chapter for information on how to program your own password after entering Administration.

Exiting Administration

Norstar stores your changes automatically as soon as you alter any settings; you do not need to "save" your changes.

1. Press **RI**.
- The display briefly shows **End of session**.

Moving through Administration

To program a setting, you must first locate the correct heading. To do this, scan through the headings of Administration using the and buttons.

To move through Administration headings:

After entering Administration, the display shows

1. Sys speed dial.

1. Press .
The display shows **2. Names.**
2. Press .
The display shows **3. Time and date.**
3. Press .
The display shows **4. Direct-Dial.**
4. Press .
The display shows **5. Capabilities.**
5. Press .
The display shows **6. Service Modes.**
6. Press .
The display shows **7. Password.**
7. Press .
The display shows **8. Log Defaults.**
8. Press .
The display shows **9. Call Services.**
9. Press .
The display shows **1. Sys speed dial.**

System Speed Dial

The System Speed Dial programming section allows you to set the Speed Dial codes for external telephone numbers which the people in your office use most often. You can program 70 System Speed Dial codes ranging from #01 to #70.

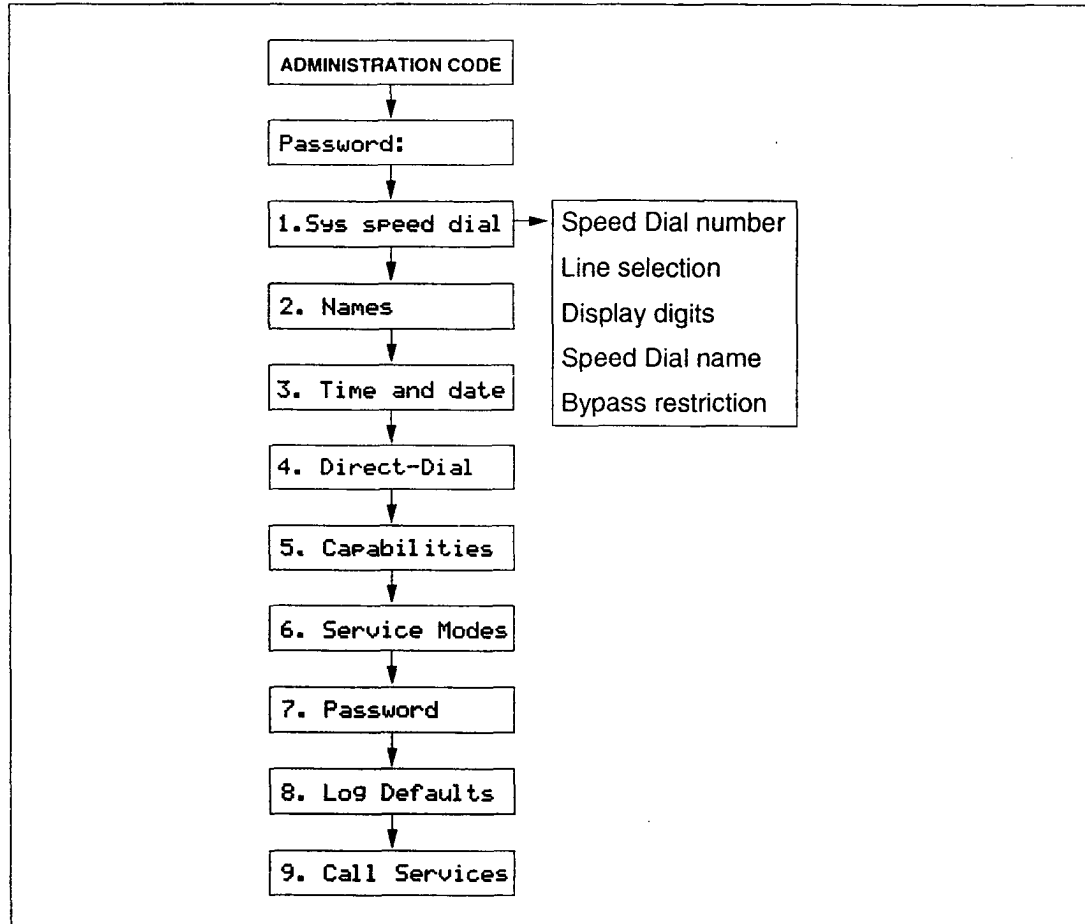

Use the Personal Speed Dial feature to program numbers used by only one or two people. See the Speed Dial section in the Telephone features chapter for more information on Personal Speed Dial codes.

System Speed Dial Number

System Speed Dial Number lets you assign a System Speed Dial telephone number to a two-digit code. The System Speed Dial Number may contain a maximum of 24 digits.

Begin with the display showing **1.Sys speed dial**.

1. Press .
The display shows **Speed dial #: _.**
2. Select the Speed Dial code you want to program:
Press until the display shows the correct code.

OR

Enter the two-digit Speed Dial code on the dial pad.

Note: To assign default settings, press **DEFAULT** and then press to go to the next Speed Dial code.

3. Press .
4. Press **CHANGE**.
For example, the display may show **#05: _.**
5. Enter the new telephone number from the dial pad, including all digits such as an initial or an area code that must be dialed to call the number manually. If you need to move the cursor back, press the **BKSP** display button.
For example, press .
6. Press **OK** to store the System Speed Dial number.

Programming hints

A Host System Signaling feature code may be inserted into the System Speed Dial number. Run/Stop and Pause each use one character position; Link and Programmed Release each use two positions.

For more information on using these features in System Speed Dial programming, see the Host System Signaling section in the Telephones features chapter.

Line Selection

Line Selection allows you to specify the external line that is used for a System Speed Dial number. The options are the **Prime line**, an external line, or a line pool.

After you have programmed a System Speed Dial number, press and the display shows:

Use **Prime line**

OR

Use **line: 02**, for example, if a line is already assigned

OR

Pool code: 42, for example, if a line pool access code is already assigned.

1. To change the setting, press **CHANGE** until the display shows the option to be programmed.
2. If you select a line number or a line pool access code, enter the digits from the dial pad. A line pool access code can be from one to four digits long.

Display Digits

Display Digits determines whether the telephone number is displayed when a System Speed Dial number is used, or whether a name associated with that number is displayed.

After you have programmed a line selection for a System Speed Dial number, press and the display shows **Display digits:Y** or **Display digits:N**.

1. Press **CHANGE** to change the setting. Options are **Y (Yes)** and **N (No)**.

System Speed Dial Name

System Speed Dial Name allows you to assign a name to the stored System Speed Dial number. When the Display Digits setting is "No", the programmed name is shown on the Norstar display when the System Speed Dial feature is used.

The name can be up to 16 characters long. The default name is the System Speed Dial number; for example, **Sys Spd Dial 02** for System Speed Dial code 02.

After programming Display digits to N, press and the display shows **Name**.

1. Press .
The display shows the assigned or default name.
2. Press **CHANGE**.
3. Enter the first character of the name by pressing the appropriate dial pad button one, two, three, or four times.
4. To move the cursor to the next position, press **-->** or .
Continue entering characters. For more information, see the Entering names heading in the Programming details section of this chapter.

Programming hints

You can program System Speed Dial Name only if Display Digits is set to No.

Bypass Restrictions

Bypass Restrictions allows the System Speed Dial number to bypass any restrictions in applied Dialing filters. Dialing filters are programmed in the Capabilities section of Administration programming.

After programming the System Speed Dial Name, press and the display shows **ByPass restr'n:N** or **ByPass restr'n:Y**.

1. Press **CHANGE** to change the setting. Options are **N (No)**, and **Y (Yes)**.

Names

You can assign names to identify external lines and your co-workers' telephones. During a call, the name (if programmed) is shown on the telephone display instead of the external line number or internal telephone number of the caller.

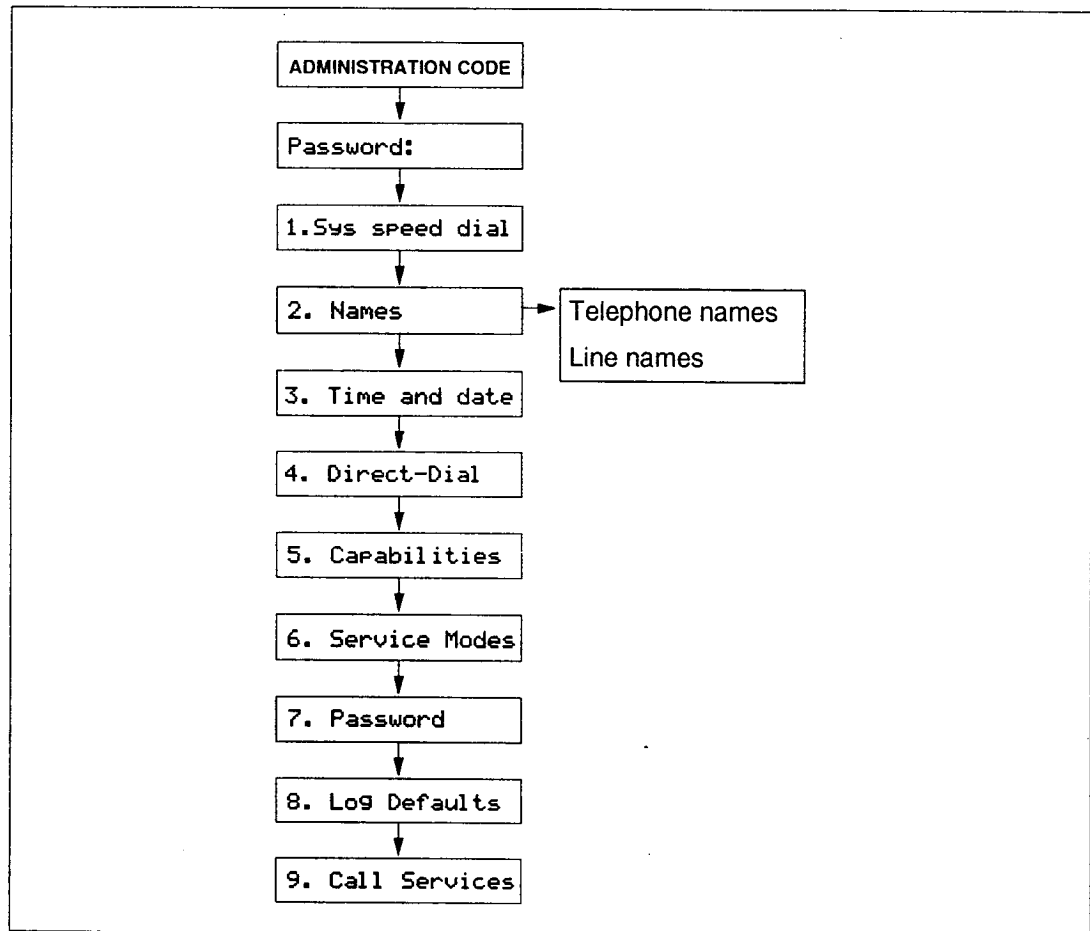

Programming hints

Telephone names and line names can contain both letters and numbers, but cannot be longer than seven characters. The # and * symbols cannot be used.

You can give the same name to two or more telephones, or to a telephone and a line in your system. To avoid confusion, you should avoid such duplication. Use initials, abbreviations, or even nicknames to give each telephone a unique name.

Two lines cannot have the same name. If you enter a line name which has already been used, you hear an error tone, and the display shows **Use unique name.**

Telephone Names

Personalize your office communication by assigning names to the telephones in the Norstar system. A telephone's default name is its internal number, for example, 27.

Begin with the display showing **1.Sys speed dial**.

1. Press .
The display shows **2. Names**.
2. Press twice.
The display shows **Show set: _**.
3. Enter the two-digit internal number of the telephone.
OR
Press for the name of the telephone with the first internal number.
4. Press **CHANGE**.
The name is removed from the display, and a cursor is shown.
5. Enter the first character of the name by pressing the appropriate dial pad button one, two, three, or four times.
6. To move the cursor to the next position, press **-->** or .
Continue entering characters. For more information, see the Entering names heading in the Programming details section of this chapter.

Programming hints

If Automatic Telephone Relocation is turned on, the name and internal number of a telephone are saved if the telephone is moved within your system.

Line Names

Line Names allows you to assign a name to an external line. The default name is the line number, for example, Line 02.

Begin with the display showing **1.Sys speed dial**.

1. Press .
The display shows **2. Names**.
2. Press .
The display shows **Set names**.
3. Press .
The display shows **Line names**.
4. Press .
The display shows **Show line: _**.
5. Enter the two-digit line number from the dial pad.
OR
Press to program the name of line 01.
6. Press **CHANGE**.
The name is removed from the display, and a cursor is shown.
7. Enter the first character of the name by pressing the appropriate dial pad button one, two, three, or four times.
8. To move the cursor to the next position, press **-->** or .
Continue entering characters. For more information, see the **Entering names** heading in the **Programming details** section of this chapter.

Time and date

Time and date programming allows you to set the time and date that is shown on the display when a telephone is not in use. As with any clock, this needs to be done every time that your office has a power failure.

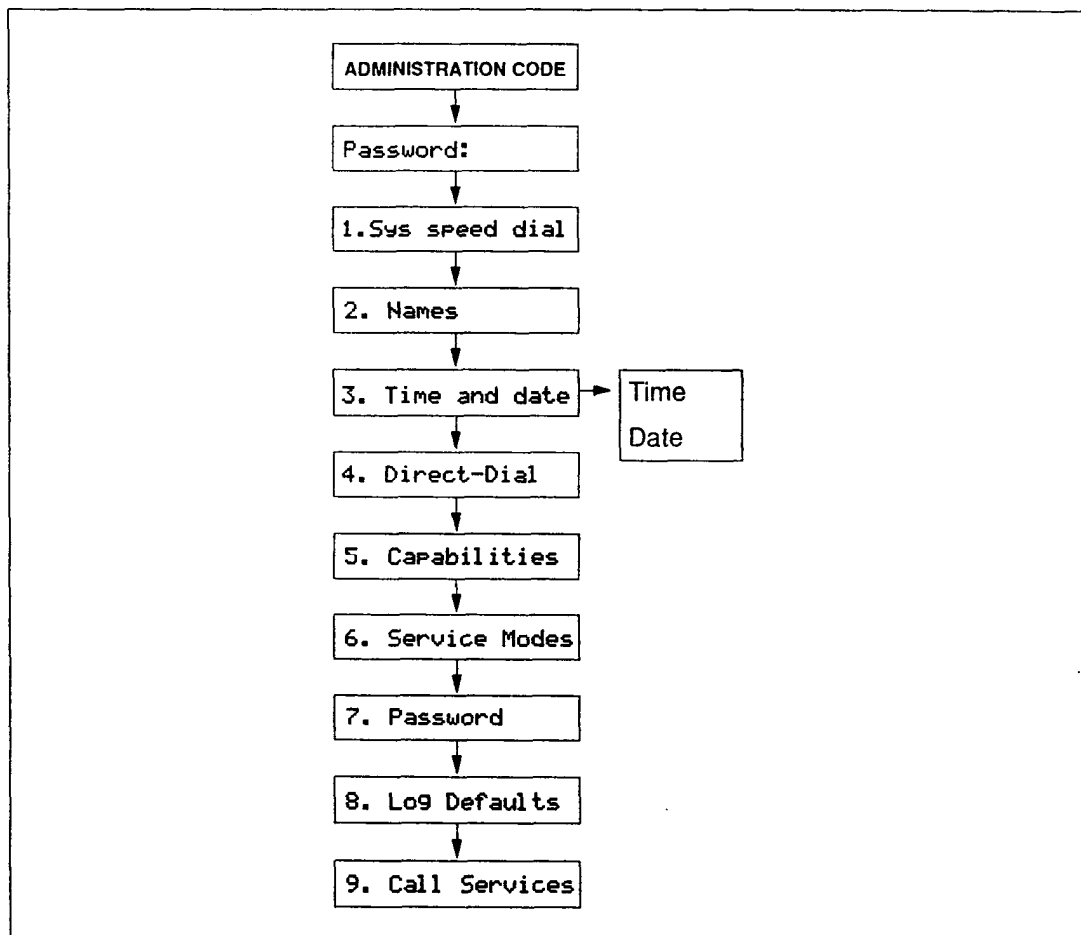

Changing the time and date is easy, but there are a couple of things to remember:

- All times and dates must be entered using numerals. For example, February would be entered as "02".
- The time may be entered in either 12- or 24-hour format. If the display is in English, and the hour entered is less than thirteen, the display prompts you to specify "AM" or "PM".
- The year is not shown on the telephone display, but make sure that it is set correctly. Norstar is programmed to allow for leap years.

- English language displays always show the time in 12-hour format, while the alternate language displays always use the 24-hour format.

Setting the time

Begin with the display showing **1.Sys speed dial.**

1. Press twice.
The display shows **3. Time and date.**
2. Press .
3. Press **CHANGE**.
The display shows the hour, for example, **Hour: 01.**
4. Set the hour.
 - a. Press **CHANGE**.
A cursor replaces the number on the display.
 - b. Enter the hour using the dial pad.
For example, press .
 - c. Press .The display shows the minutes, for example, **Minutes: 00.**
5. Set the minutes.
 - a. Press **CHANGE**.
A cursor replaces the number on the display.
 - b. Enter the minutes using the dial pad.
For example, press .
 - c. Press .If the hour entered in step 4 is less than thirteen, the display shows **AM**.
6. To switch the message to **PM**, press **CHANGE**.
To switch it back to **AM**, press **CHANGE** again.

Setting the date

Begin with the display showing **1. Sys speed dial.**

OR

After having set the time, press and go to step 4.

1. Press twice.
The display shows **3. Time and date.**
2. Press .
3. Press .
4. Press **CHANGE**. The display shows **Year: 92.**
5. Set the year.
 - a. Press **CHANGE**.
A cursor replaces the number on the display.
 - b. Enter the year using the dial pad.
For example, press to enter the year 1993.
 - c. Press .
6. Set the month.
 - a. Press **CHANGE**.
A cursor replaces the number on the display.
 - b. Enter the month using the dial pad.
For example, press to enter April.
 - c. Press .
7. Set the day.
 - a. Press **CHANGE**.
A cursor replaces the number on the display.
 - b. Enter the day using the dial pad.
For example, press .

Direct-Dial

Direct-Dial programming allows you to call the Direct-Dial telephone assigned to your telephone by dialing a single digit. Use the **Direct-Dial** heading to specify the telephone directory number (DN) designated as the Direct-Dial telephone.

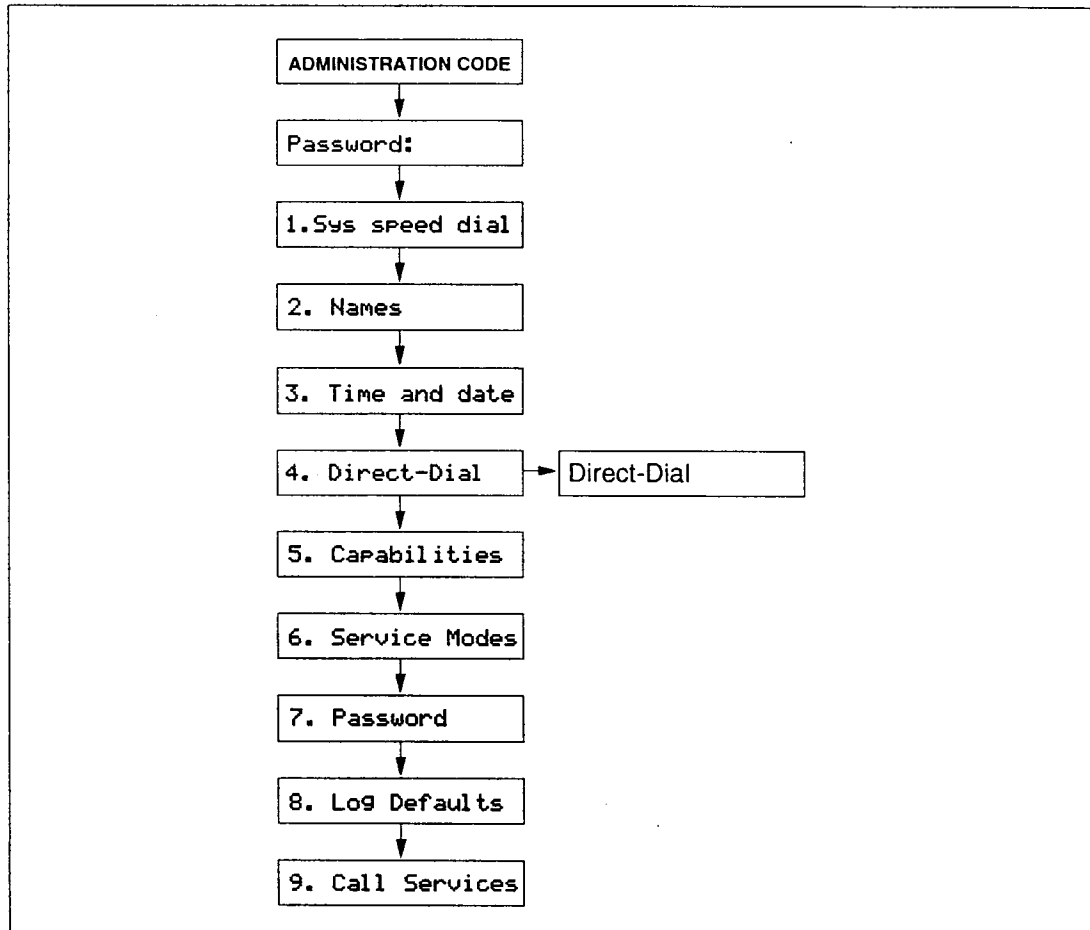

Use the button, the **CHANGE** display button and the dial pad to enter the internal number of the telephone to be designated as the Direct-Dial telephone.

Programming hints

To complete Direct-Dial telephone programming, assign a Direct-Dial telephone to each telephone in the system using the Capabilities section of Administration programming.

The digit you dial in order to get the Direct-Dial telephone to ring can be programmed by your Customer Service representative.

Capabilities

Capabilities programming assigns restrictions and exceptions to Class of Service (COS) passwords, telephones, and lines.

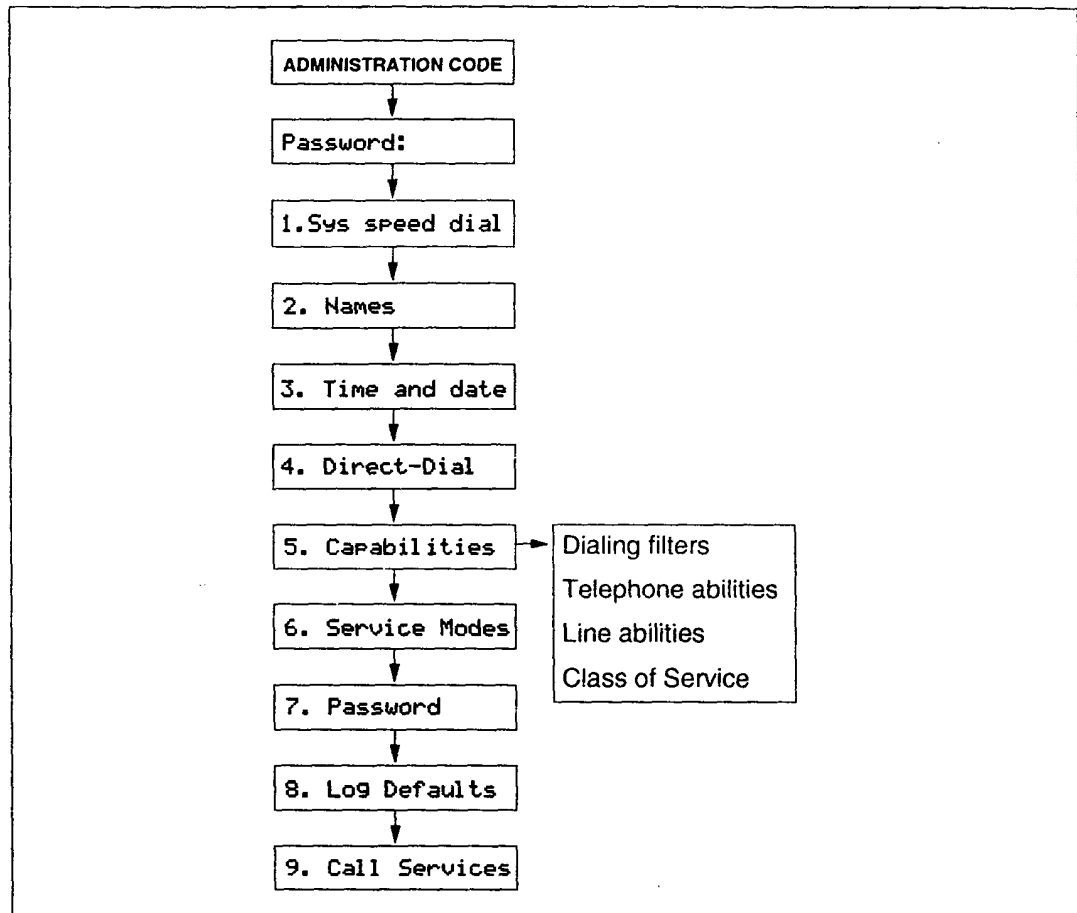

Dialing Filters

A dialing filter is made up of restrictions and exceptions. These specify the external numbers which can or cannot be dialed from a telephone or on a line.

After dialing filters are defined, they may be used as telephone (set) filters, line filters and line/set filters to manage outgoing calls.

Use the button, the **ADD** display button, the dial pad, and the **OK** display button to program the restrictions and exceptions for each dialing filter.

Use the button, the **ADD** display button, the dial pad, and the **OK** display button to program the restrictions and exceptions for each dialing filter.

Press the **ANY** display button to enter a • wild card character that represents any digit in a sequence of numbers.

For example

You may need filters for three different types of users:

- Managers may require unrestricted dialing.
- Secretaries may need to be limited to calling the West coast office on line 03 only.
- Clerks may need to be limited to calling specific area codes and the West coast office.

Dialing filters are most commonly used to prevent unauthorized long-distance calls, without restricting local calls. Dialing filters restrict the numbers that an internal user can dial on external lines.

If a line/set filter has been defined for the line selected at the user's telephone, it overrides any line filters or telephone filters which might otherwise apply.

If no line/set filters have been defined, dialed digits are filtered through (and may be rejected by either of) the telephone filter (if defined) and the line filter (if defined).

Programming hints

- Norstar can have up to 20 dialing filters (00 to 19).
- Filter 00 cannot be changed.
- Each programmable filter can have up to 48 restrictions; there is no limit on the number of exceptions that can be allocated to any restriction.
- There is a maximum of 200 restrictions and exceptions allocated to the 24 programmable filters. For example, notice the reduction in the number of available restrictions and exceptions after each filter has been programmed.

Filter	User type	Rest's	Excep's	Remaining
00	manager	— —	— —	200
01	secretary	5	5	190
02	clerk	7	12	171
Total		12	17	(200 - 12 - 17 = 171)

- The maximum length for a restriction is 15 digits; for an exception, the maximum is 16 digits.

- The • is a "wild card" character that stands for any digit.
- You can use an asterisk * in a sequence of numbers in either a restriction or an exception. This character is often used as part of feature codes for other systems or for features provided by your central office.

Note: If you are using an earlier version of KSU software, the asterisk * is used as the "wild card".

- When restricting the dialing of a central office feature code, do not forget to create separate restrictions for the codes used for DTMF and pulse lines. For example, *67 and 1167.
- Do not string together a central office feature code and a dialing sequence that you want to restrict. Create a separate restriction for each.
- You can use COPY and the dial pad to copy restrictions and overrides from one dialing filter to another.
- Any restriction or exception can be used in any number of filters. Each time it is used, it counts as one entry. For example, if restriction 411 exists in filters 01, 02 and 03 it uses up three of the 200 entries available.
- Removing a restriction also removes the exceptions associated with it, and changes the identifying number of the remaining restrictions. For example, removal of restriction 01 renumbers restrictions 01 to 48 as 01 to 47.

Note: The removal of a restriction from one dialing filter has no effect on the contents of other filters into which the restriction was copied.

- You cannot delete a filter. Removing the restrictions programmed on a filter makes it an unrestricted filter but the filter is not removed.

Filter descriptions

- Filter 00 permits unrestricted dialing, and cannot be changed.
- Filter 01 is pre-programmed with five restrictions and some associated exceptions.

Filter	Restrictions	Exceptions
00	Unrestricted dialing	
01	0	
	1	1800 1555 1•1•555 1•0•555
	911	911
	411	
	976	
02 - 24	None	

- Filters 02 and 03, although not pre-set with restrictions and exceptions, are the default filter settings used later in programming:

Filter	Where the filter is programmed as a default setting in Capabilities programming	
02	Set abilities	Set filter:
03	Line abilities	Line filter:

Telephone (Set) abilities

Telephone (Set) abilities programming assigns dialing filters and specific settings to telephones. Telephone abilities include:

Telephone (set) filters	Direct-Dial telephone
Line/telephone filters	Call Forward On Busy
Telephone Administration Lock	Call Forward No Answer
Full Handsfree	Forward No Answer delay
Automatic Handsfree	Allow redirect
Handsfree Answerback	Redirect ring
Call Pickup Group	Receive tones
Paging	Hotline
Page Zone	Priority Call
Auxiliary Ringer	

Telephone (Set) filter

A Telephone filter is a collection of restrictions and exceptions defined in Dialing filters. These filters are applied to telephones through Set filter programming.

Use the button, the **CHANGE** display button and the dial pad to enter the number of the Dialing filter to be assigned as the Telephone filter. **Filter 02** is the default set filter.

Line/telephone (Line/set) filter

A Line/telephone filter is applied to the appearance of a line at a specific telephone. This type of filter replaces any Line or Telephone filters which might otherwise apply.

Line/set filters control the numbers that may be dialed on specific external lines from specific telephones.

For example, a Line/set filter can permit a call to a specific long-distance number on line 03 from a specific telephone, but no other long-distance numbers, and on no other line.

Use the button, the **CHANGE** display button and the dial pad to enter the number of the Dialing filter to be assigned as the Line/telephone filter.

Programming hints

- A maximum of 255 Line/telephone dialing filters may be applied to lines at telephones across the entire system.

Telephone Administration Lock (Set Lock)

Telephone Administration Lock limits the types of features that may be used or programmed at a telephone. Use the **CHANGE** display button to select one of the three options: **None**, **Partial** and **Full**.

None allows you to access any feature on your telephone.

Partial prevents:

- programming Autodial buttons
- programming Personal Speed Dial numbers
- programming feature buttons
- moving line buttons
- changing the display language
- changing Dialing Modes (Automatic Dial, Pre-Dial, and Standard Dial)
- using Voice Call Deny
- using Administration programming
- saving a number with Saved Number Redial

Full, in addition to the restrictions outlined for Partial lock, prevents:

- changing Background Music
- changing Privacy
- changing Do Not Disturb
- using Ring Again
- using Call Forward all calls
- using Send Message
- using Trunk Answer
- activating Service Modes

Full Handsfree

Full Handsfree allows you to make or receive calls without picking up the receiver, and allows a headset to be used with the Norstar telephone. Use the CHANGE display button to select the setting: **N (No)** or **Y (Yes)**.

Programming hints

A  button is automatically assigned to a telephone that is programmed with Full Handsfree. Full Handsfree is always disabled for an M7100 Telephone.

Automatic Handsfree

Automatic Handsfree activates the Handsfree microphone and speaker when you make or receive calls by pressing a line button. Use the CHANGE display button to select the setting: **N (No)** or **Y (Yes)**.

Programming hints

You can program Automatic Handsfree only if the telephone has Full Handsfree set to Yes.

Handsfree Answerback

Handsfree Answerback allows you to answer a Voice Call without lifting the receiver. Use the CHANGE display button to select the setting: **Y (Yes)** or **N (No)**.

Programming hints

Handsfree Answerback is always disabled for an M7100 Telephone.

Call Pickup (Group)

Each telephone can be assigned to two of up to four Call Pickup groups. Members of a Call Pickup group can answer any calls ringing at a telephone in the group. Use the CHANGE display button to select the setting: **NO**, **1**, **2**, **3**, or **4**.

Programming hints

You cannot pick up a call that is on a Private line, or a call that is ringing only the Auxiliary Ringer.

Paging

This setting determines whether a telephone has access to the Page feature. Use the CHANGE display button to select the setting: **Y (Yes)** or **N (No)**.

Page zone

Each telephone can be assigned to one of three zones for receiving Page messages. A zone is any selection of Norstar telephones you want to group together, regardless of location. Use the CHANGE display button to select the setting: **1**, **2**, **3**, or **NO**.

Programming hints

The Page zone setting has no effect if the telephone has Paging set to No.

Auxiliary Ringer

This setting causes the Auxiliary Ringer (if installed) to ring when the telephone rings. An Auxiliary Ringer is important in noisy environments where a Norstar telephone might otherwise not be heard. Use the CHANGE display button to select the setting: **N (No)** or **Y (Yes)**.

Direct-Dial telephone

A telephone can be assigned to call the Direct-Dial telephone when you dial a single digit. Use the CHANGE display button to select the setting: **Set1** or **None**.

Programming hints

Any number of telephones can be assigned to call a particular Direct-Dial telephone.

The digit you dial in order to get the Direct-Dial telephone to ring can be programmed by your Customer Service representative.

Call Forward On Busy

Call Forward On Busy redirects an incoming call to another telephone on your Norstar system when you are busy on a call, or when you have Do Not Disturb activated at your telephone.

Use the button, the **CHANGE** display button, and the dial pad to program the internal number of the telephone that your calls are to be directed to.

Programming hints

Line Redirection takes precedence over Call Forward On Busy.

Call Forward No Answer

Call Forward No Answer lets you redirect an incoming call to another telephone on your Norstar system when the call is not answered at your telephone.

Use the button, the **CHANGE** display button, and the dial pad to program the internal number of the telephone that your calls are to be directed to.

Programming hints

Line Redirection takes precedence over Call Forward No Answer.

Forward No Answer delay

If you assign another telephone to receive your calls, you can also assign the number of times that the incoming call rings before the call is forwarded. To estimate the delay time in seconds, multiply the number of rings by six. Use the **CHANGE** display button to select the setting: 2, 3, 4, 6, or 10 rings.

Allow redirect

Allow redirect enables you to identify whether a telephone is allowed access to the Line Redirection feature. Use the **CHANGE** display button to select the setting: Y (Yes) or N (No).

See the explanation of Line Redirection in the Telephone features chapter for more information on redirecting lines.

Programming hints

The Allow redirect setting has no effect if Disconnect Supervision is unavailable or was not enabled by your Customer Service representative. See the System features section of the Telephone features chapter for more information on Disconnect Supervision.

Redirect ring

The Redirect ring setting causes a telephone to ring briefly (a 200 millisecond burst) when a call is redirected on one of its lines. Each telephone with a ringing appearance of that line also rings briefly for the redirected call if the Redirect ring setting for them is 'Y' (the default). Use the CHANGE display button to select the setting: **Y (Yes)** or **N (No)**.

A user enters the Line Redirection feature code to redirect calls. See the explanation of Line Redirection in the Telephone Features chapter for more information on redirecting lines.

Programming hints

The Redirect ring setting has no effect if Disconnect Supervision is unavailable or was not enabled by your Customer Service representative. See the System features section of the Telephone features chapter for more information on Disconnect Supervision.

Receive tones

The Receive tones setting allows the system to accept and relay tones to the internal lines. Tones are required if you want to connect an answering machine or a fax on an internal line. Use the CHANGE display button to select the setting: **N (No)** or **Y (Yes)**.

Hotline

Hotline automatically calls a pre-assigned number when you lift the receiver or press at your telephone. Hotline has three options: **None**, internal (**Intrn1**), and external (**Extrn1**).

Internal assigns an internal number.

External assigns an external number. If you select an external number, you can also select the line on which the call is made: the Prime line, an external line, or a line pool. You will have to specify the Line Pool Access code for a line pool.

Use the CHANGE display button to select the Hotline setting. If you select **Intrn1**, use the button, the CHANGE display button, and the dial pad to program the internal number of the telephone that Hotline calls are to be directed to.

If you select **Extn1**, use the button, the **CHANGE** display button, and the dial pad to program the external telephone number that Hotline calls are to be directed to, and to program the line Hotline calls are to be made on.

Programming hints

The telephone should be labeled to inform anyone using it that Hotline is active.

A telephone's Prime line, line pool access codes, and access to a line pool can be programmed by your Customer Service representative.

Priority Call

This feature lets you call from your Norstar telephone and interrupt calls or override Do Not Disturb on another Norstar telephone. Use the **CHANGE** display button to select the setting: **N (No)** or **Y (Yes)**.

Programming hints

Apply this feature only to telephones from which such interruptions can be justified.

Line abilities

Line abilities programming assigns dialing filters to lines.

Line filter

A Line filter is a collection of restrictions and exceptions defined in a Dialing filter, and applied to an outgoing line. A Line filter on an outgoing line may be used to limit the capabilities of that line to carry calls made to specific area codes or destinations.

Use the **CHANGE** display button, and the dial pad to program the Line filter. **Filter 03** is the default Line filter.

Class of Service (COS) passwords

Class of Service (COS) passwords permit controlled access to a system's resources. Class of Service programming defines passwords, their associated dialing filters and user filters.

A Class of Service can be associated with a telephone, a line or a COS password. It determines the dialing capabilities that apply to internal telephones and any lines used for external calls.

Users have a Class of Service associated with their telephones, in the sense that there are dialing filters associated with telephones, as well as line pool assignments. Use of a COS password affects only the telephone's dialing capabilities.

The ability to change the COS internally means that someone using another person's telephone can temporarily change the restrictions that would normally be applied.

Password security

- Class of Service passwords for a system should be determined randomly, and should be changed on a regular basis.
- System users should memorize their COS passwords instead of writing them down.
- Employees' COS passwords should be deleted when they leave the company.

Programming hints

- A system can have a maximum of 20 six-digit COS passwords (00 to 19).
- You can copy the data from one COS password to another COS password using the COPY display button in the same way that telephone and line data can be copied.
- COS passwords must be unique.

Programming COS passwords

Use the button, the CHANGE display button, and the dial pad to program the six-digit sequences for each password. Use the BKSP display button to edit digit sequences you have entered.

User filter

The COS User filter replaces the telephone (set) filter or the line/set filter that would otherwise apply to a specific call.

Use the button, the **CHANGE** display button, and the dial pad to program the two-digit User filter. The default setting (**Def1 t.**), means that any other filters in place (telephone (set) filter or line/set filter) still apply.

Line filter

The COS Line filter replaces the line filter that would otherwise apply to a specific call.

Use the **CHANGE** display button, and the dial pad to program the two-digit Line filter. The default setting (**Def1 t.**), means that any Line filter already programmed still applies.

You can assign a Control telephone to more than one external line, but a line cannot be assigned to more than one Control telephone.

Only one Service Mode applies at any one time to all external lines controlled by a given Control telephone.

The default Control telephone for all lines is **21**.

Service Modes

The three Service Modes are programmed in the same way.

Service Mode Name

The Service Mode Name identifies the active Service Mode, and is shown on the display of the Control telephone when the Service Mode is turned on.

Use the button, the **CHANGE** display button, and the dial pad to program the Service Mode name. For information on entering names, see the information in this chapter entitled Entering names.

Programming hints

The default names of the three possible Service Modes are only suggestions, and may be changed to any other name.

A Service Mode name can be one to seven characters.

Service Mode setting

The Service Mode setting controls how the Service Mode is turned on and off. Use the **CHANGE** display button to select the setting: **Manual**, **Automatic**, or **Off**.

Manual allows you to turn the Service Mode on and off at any time from a Control telephone. The Service Modes feature code must be entered at the telephone to access this feature.

Automatic allows you to pre-assign a stop and start time during which the Service Mode is active. You are still able to start and stop the Service Mode by entering the Service Modes feature code at a Control telephone. If you select this setting, you will have to program start and stop times. See the section in this chapter on Time and Date for information on programming times.

Off prevents the Service Mode from being activated.

Programming hints

You can only program start and stop times when the Service Mode is set to Automatic.

Overlapping times may be assigned. For example, if Service Mode 1 is assigned from 9:00 am to 4:00 pm and Service Mode 2 is assigned from 1:00 pm to 5:00 pm, then the start time of the second Service Mode is treated as a stop time for the first Service Mode. This is also true if two Service Modes have the same start time but different stop times.

If one Service Mode starts and stops within the times of another Service Mode, the first service temporarily ends when the second service starts. The first service then resumes when the second service has ended.

Default stop and start times correspond to typical hours which may be required for a night Service Mode.

Default Service Mode times

Service Mode	Start time	Stop time
Service Mode 1: Night	23:00	07:00
Service Mode 2: Evening	17:00	23:00
Service Mode 3: Lunch	12:00	13:00

Trunk Answer

Trunk Answer allows you to answer, from any telephone, an external call which is ringing at another telephone in your office. This is useful if the other telephones have not been assigned the same lines as the telephone you are using to answer the call.

You can change the Trunk Answer setting only if the Service Mode is set to Manual or Automatic.

Use the CHANGE display button to select the setting: **Y (Yes)** or **N (No)**.

Extra-Dial telephone

A telephone normally in service as a Direct-Dial telephone, can be programmed in Service Modes to allow internal calls to the Direct-Dial telephone to also ring at the Extra-Dial telephone.

Use the CHANGE display button and the dial pad to enter the internal telephone number of the Extra-Dial telephone.

Programming hints

The Extra-Dial telephone provides the option of assigning one more Direct-Dial telephone in the Norstar system for each operational Service Mode.

Ringing telephones (sets)

You can assign additional telephones to ring for incoming calls on each external line. Use the button, the ADD display button and the dial pad to enter the internal telephone numbers of the Ringing telephones for each line.

Programming hints

The default ringing telephone is **21**. This means that all lines ring at telephone 21, when Service Modes are activated. Ringing telephones can be assigned to more than one Service Mode.

Auxiliary ringer

You can indicate whether the Auxiliary Ringer (if installed) also rings when a Service Mode is activated. Use the CHANGE display button to select the setting: **Y (Yes)** or **N (No)**.

Password

The Administration password allows access to Administration programming. This prevents unauthorized or unintentional changes to settings. To ensure security, distribute the password only to selected personnel, record your password in the *Compact DR5 Programming Record*, and change the password periodically.

The password is a one to six-digit number. The default Administration password is which is the same as .

Use the button, the **CHANGE** display button and the dial pad to enter the new Administration password. Use the **OK** display button to accept the programmed password.

Programming hints

The password is easier to remember if the digits correspond to the letters in a word.

If you forget the Administration password, you are not able to access Administration programming. Call your Customer Service representative to assign a new Administration password.

Log Defaults

If you subscribe to Call Display services, external calls can be tracked in a Call Log. Log Defaults programming customizes how log space is allocated to telephones throughout the system.

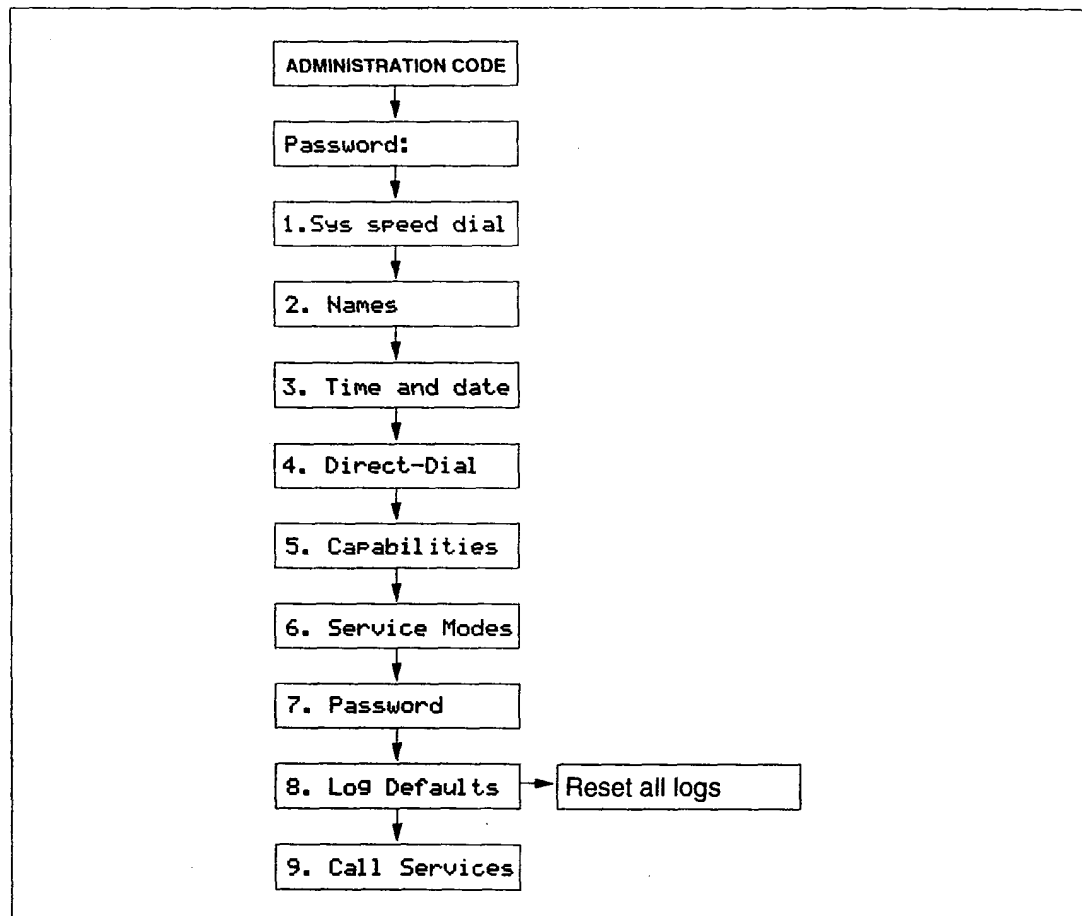

Reset All Logs

Use the button and the dial pad to enter the space allocation for the Call Log at each telephone. Use the **OK** display button to accept the settings and end Administration programming. The system automatically reallocates Log space.

Note: Reallocation of Call Log space may destroy Call Log data at telephones that lose space.

There are 160 Call Log spaces available in the system. There are no spaces allocated by default. Changing the space allocation using Log Defaults will define the log space available to every telephone in the system. Unassigned log space is available in a Log Pool and can be re-allocated in Call Services programming.

Call Services

If you subscribe to Call Display services, external calls are identified on the display. Call Services programming allows you to customize how this information is used.

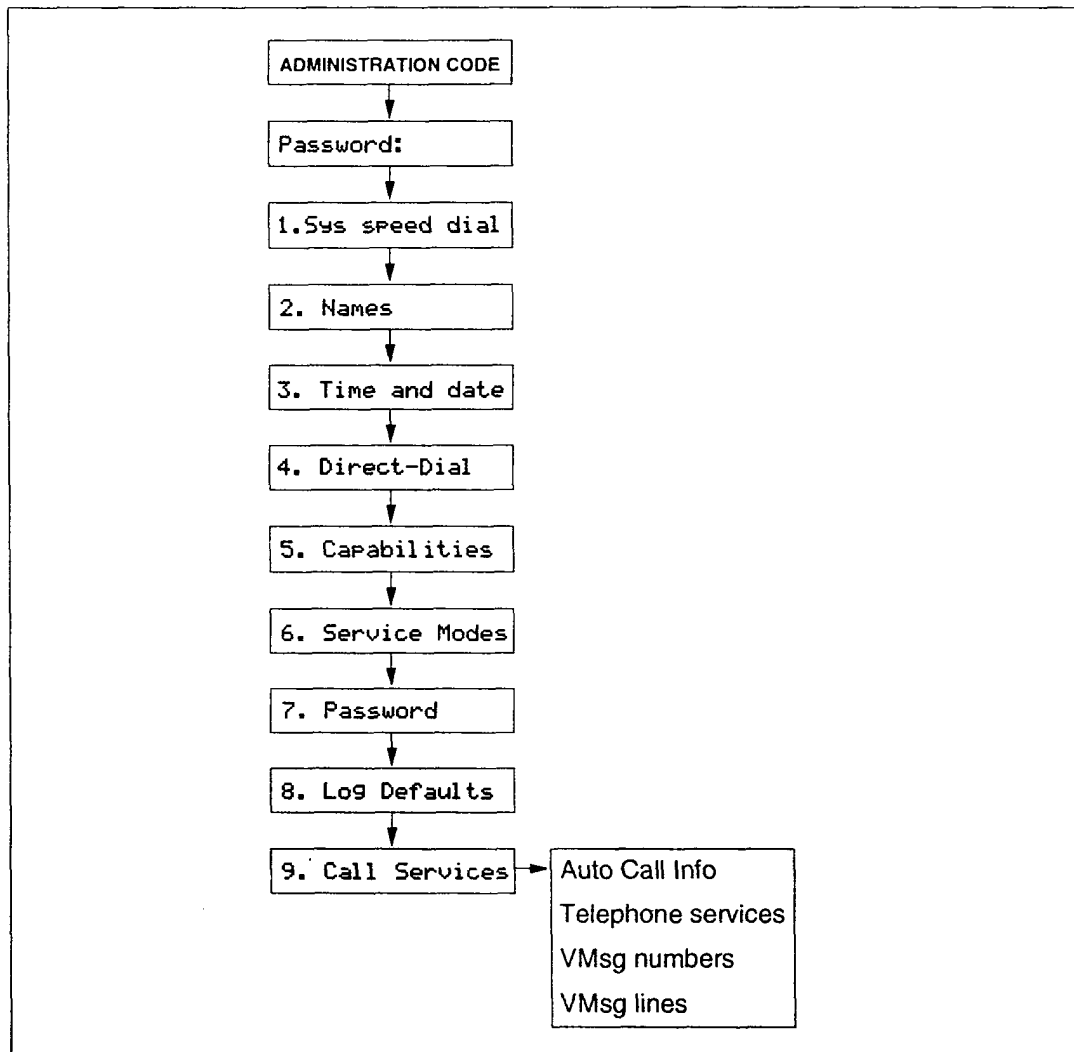

Auto Call Info

Automatic Call Information allows you to specify which telephone displays the Call Display information when a call is ringing on an external line. (After the call is answered, Call Display information is always shown at the telephone that answered the call.) Use the **CHANGE** display button and the dial pad to enter the internal number of the telephone to display Call Display information.

Note: In order for a telephone to display the Call Display information for calls on an external line, that telephone must also be programmed to ring for that line.

Telephone (Set) Services

Telephone Services programming allows you to customize how Call Display information is used at each telephone.

Autolog/Show Voice Message

Logging telephone (set)

Logging telephone allows you to specify the telephone that automatically logs Call Display information for calls on an external line. The line must appear on that telephone but it does not have to be a ringing line. Use the CHANGE display button to select the setting: **N (No)** or **Y (Yes)**.

Show External Voice Message

If you subscribe to a Voice Message service, you can access that service through your Norstar system. Show External Voice Message controls the display of the External Voice Message Waiting indication for each line at each telephone. The telephone must have an appearance of that line. Use the CHANGE display button to select the setting: **N (No)** or **Y (Yes)**.

Log Space

Log Space changes the number of items that can be stored in the Call Log for each telephone. Use the button, the ADD display button and the REMOVE display button to redistribute the log space. There is no log space assigned by default.

Programming hints

Space must be available in the Log Pool before any space can be added to a current Call Log space.

System-wide allocation of space is performed from Log Defaults programming. If you are performing extensive changes, it may be appropriate to use the Log Defaults programming mechanism instead.

Log Password

Log Password allows you to clear any Call Log password programmed with the Call Log feature. Use the CHANGE display button to clear the password programmed by the user. The setting is **None** until the user programs a password.

First Display

Depending on the services you subscribe to, Call Display information may contain up to three parts; the name of the caller, the number of the caller, and the name of the line in your Norstar system that the call is on. Use the **CHANGE** display button to select the setting to be shown first for each telephone: **Name**, **Number** or **Line**.

Programming hints

The Call Information feature is used to display and scroll through all of the Call Display Information: the caller name, number and line number. See the Telephone features chapter for more information.

You may see **Unknown name** or **Unknown number** on the display if the information is not available from your telephone company. You may see **Private name** or **Private number** on the display if the caller blocks that information.

Voice Message Center telephone numbers

If you subscribe to a Voice Message service, you can access that service through your Norstar system. This setting specifies the external telephone number that is automatically dialed by the Message feature to retrieve voice messages. Use the **CHANGE** display button and the dial pad to enter the external telephone number for each Voice Message Center.

Programming hints

The display does not show that external messages are waiting unless the Show External Voice Message prompt is set to Yes.

Five Voice Message Center numbers can be programmed, but most systems require only one.

Voice Message Center lines

If you subscribe to a Voice Message service, you can specify which Voice Message Center is used for each external line that can receive Message Waiting Indication. Use the **CHANGE** display button to select the setting: **1**, **2**, **3**, **4**, **5**, or **N** (None).

Copying settings

Programmed settings for lines, telephones, and certain Capabilities can be copied to other lines or telephones. If many lines or telephones require the same settings, program one line or telephone, and then copy those settings.

Line programming

Line programming can be copied for Line abilities in the Capabilities section of Administration programming, and Ringing telephones in the Service Modes section of Administration programming.

Use the COPY display button and the dial pad to identify the source and destination of the copied information.

Telephone programming

Norstar telephone programming can be copied for Set Abilities in the Capabilities section of Administration programming.

Use the COPY display button and the dial pad to identify the source and destination of the copied information.

Capabilities programming

In addition to Line abilities and Set abilities, Norstar Capabilities programming can be copied for:

- Dialing filters
- COS passwords

Use the COPY display button and the dial pad to identify the source and destination of the copied information.

Programming reminders

The Programming reminders are a record of programmable settings which Norstar users may need to know on a day-to-day basis.

Fill out whatever sections are programmed and must be known. Not all of the programmable features may be required information.

Programmed settings can be determined from a review of the *Compact DR5 Programming Record*.

Photocopy and distribute the Programming reminders to each desk that has a Norstar telephone, or post them on the wall next to the telephone.

Prime telephone

Prime Telephone operator			
Internal number			___
Lines answered at the Prime telephone	___	___	___
	___	___	___

Page zones

Page zone	Description
1	
2	
3	

Line Pools

Pool	Access code	Use
A	___	
B	___	
C	___	

Miscellaneous programming

Direct-Dial telephone	___
Direct-Dial digit	___
Call Park Prefix digit	___
Dial first to make external calls	___

Control telephones

Line 01	___
Line 02	___
Line 03	___
Line 04	___
Line 05	___
Line 06	___

Call Pickup Groups

Pickup Group	Names of members of the group	
—	_____ _____ _____ _____ _____	_____ _____ _____ _____ _____
—	_____ _____ _____ _____ _____	_____ _____ _____ _____ _____
—	_____ _____ _____ _____ _____	_____ _____ _____ _____ _____
—	_____ _____ _____ _____ _____	_____ _____ _____ _____ _____

Telephone features

Answer a call

Answering the telephone 3-6
 Call Information 3-19
 Call Pickup 3-7, 3-33

Bring another person into a telephone conversation

Conference 3-39
 Group Listen 3-62
 Handsfree/Mute 3-7, 3-63
 Privacy 3-39
 Unsupervised Conference[†] 3-41, 3-107

Change your telephone defaults

Button Inquiry 3-59
 Class of Service 3-44, 3-101
 Contrast Adjustment 3-45
 Customizing your telephone 3-45
 Dialing Modes 3-46
 Do Not Disturb 3-7, 3-17, 3-58
 Feature programming 3-59
 Language Choice 3-47
 Line appearance 3-102
 Line buttons 3-48, 3-85
 Lines 3-102
 Norstar Telephones 3-84
 Prime line 3-104
 Private lines 3-103
 Ring Type 3-49
 Ring Volume 3-50
 Telephone Admin. Lock 3-50

Check the length of a call

Call Duration Timer 3-105
 Show Time 3-105

Communicate within your office

Dialing 3-52
 Direct-Dial 3-52, 3-94
 Page 3-88
 Priority Call 3-90
 Ring Again 3-53
 Voice Call 3-111

Handle many calls at once

Answer buttons 3-84
 Call Queuing 3-36
 Hold 3-65, 3-84
 Prime telephone 3-7, 3-96

Have your calls answered at another telephone

Call Forward 3-16
 Line Redirection[†] 3-72
 Service Modes 3-92

Log your incoming calls

Autobumping 3-23
 Call Log 3-21
 Logit 3-22

Make calls quickly without having to dial the whole number

Autodial 3-13
 Hotline telephone 3-95
 Last Number Redial 3-52
 Messages 3-78
 Saved Number Redial 3-53
 Speed Dial 3-97

Make calls to numbers outside your Norstar system

Dialing 3-52
 External line access code 3-52
 Host System Signaling 3-67
 Line Pools 3-70, 3-103

Transfer a call to another person

Call Park 3-31
 Camp-On 3-37
 External Transfer[†] 3-106
 Transfer 3-37, 3-106

[†] Some external lines may not support this feature. See the Availability of features heading in the Using Norstar features section.

Using Norstar features

To use a Norstar feature, enter the feature code and watch your telephone display for instructions. Different displays come up at different times, depending on how you invoke the feature and the choices you make while using the feature. If you want more information about a display, look it up in the Displays section of each feature listing.

Availability of features

Some features work only in certain circumstances. For example, Disconnect Supervision must be available and assigned to a line on your telephone to allow you access to the following features:

- Line Redirection of an external call to an external number
- Unsupervised Conference between two external calls
- Transfer between two external calls

Disconnect Supervision is available when an Open Switch Interval (OSI) message is provided on a line by the public telephone system.

If Disconnect Supervision is available, your Customer Service representative assigns Disconnect Supervision to lines in Configuration programming. When Disconnect Supervision is assigned to a line, the Norstar system monitors the length of the OSI on that line to determine when an external caller hangs up. This allows the system to release the line for other uses.

The Notes section of each feature listing contains information concerning any restrictions affecting the availability of the feature.

One-line and two-line displays

All Norstar telephones have LCD displays that give you information about your calls and guide you through Norstar features. The M7100 and M7208 Telephones have a one-line display. The M7310 and M7324 Telephones have a two-line display. The second line of a two-line display shows the functions of the three buttons directly below it. If you have a telephone with a two-line display, you can use these display buttons. Some display buttons, such as TRANSFER and ALL, are simply shortcuts. If you have a telephone with a one-line display, these shortcuts are not available. Other display buttons, such as OK and SHOW, perform essential functions. If your telephone has a one-line display, you can use the following buttons in place of these display buttons:

<u>OK</u>	<input type="text" value="Hold"/>	<u>CANCEL</u>	<input type="text" value="#"/>
<u>QUIT</u>	<input type="text" value="Rls"/>	<u>VIEW</u>	<input type="text" value="#"/>
<u>ADD</u>	<input type="text" value="*"/>	<u>OVERRIDE</u>	<input type="text" value="#"/>
<u>SHOW</u>	<input type="text" value="#"/>	<u>BKSP</u>	<input type="text" value="◀▶"/>

All displays listed in this Guide are shown as they appear on the two-line display, except those that appear only on telephones with a one-line display. If you are using a telephone with a one-line display, ignore both the second line of the display shown in this Guide, and the instructions for using display buttons.

Common feature displays

You may see the following displays when you use a feature.

Access denied

Someone is using Configuration or Administration programming. You cannot use programming features. Try again later.

Feature timeout

You have taken more than 15 seconds to press a button in response to a display.

Invalid code

You have entered an invalid feature code.

Not available

You have tried to use a feature that is not available in the present set-up of your Norstar system.

Set locked

You cannot use the feature you have chosen because your telephone is locked. See Telephone Administration Lock in Customizing your telephone.

Dialing and answering the telephone

Many Norstar features require you to dial telephone numbers. The displays associated with dialing are listed in the Dialing section. If you see a display that is not listed with the feature you are using, look for it in the Dialing section. All the displays that appear when you are receiving a call are listed in the Answering the telephone section.

One button access

You can program most Norstar feature codes onto telephone memory buttons so that you can use the feature by pressing a single button. See the procedures in the Feature programming section.

Whenever the instructions tell you to enter a feature code, you can do so either by pressing the buttons shown in the feature description or by pressing a memory button on which the feature code has been programmed. You can also enter a telephone number by pressing an Autodial button, rather than entering it manually.

Canceling a feature

Some features change the way your telephone works. To make your telephone work normally again you must cancel the feature. To cancel a feature, press , then # and the feature code. For example, to cancel Call Forward, which you activate by pressing 4 , press # 4 .

If a feature code is programmed onto a memory button, you may be able to cancel the feature by pressing the memory button while the feature is active.

If you change your mind in the middle of using a feature, you can back out by pressing or . **Be aware that pressing disconnects any active call.**

M7100 Telephone

Because the M7100 Telephone does not have any line buttons it sometimes works slightly differently from other Norstar telephones. Where other telephones may require you to select a line button to answer a call, on the M7100 Telephone you simply pick up the receiver. Where other telephones require you to select a line button to take a call off hold, you press on the M7100 Telephone. The M7100 Telephone cannot have a button. You will find special instructions for the M7100 Telephone in some feature descriptions.

Answering the telephone

Answering

Your Norstar telephone can receive many different types of calls. Your telephone's display tells you what type of call you are receiving. The usual way to answer a call is to pick up the receiver, but there are several other possible methods, depending on how your system is set up and the type of call that is ringing.

Callback

When you direct a call you have answered to another telephone, the system monitors the call to make sure someone answers it. If no one answers a call within a programmable length of time, the system directs it back to you. Callback generates a variety of displays. Most occur after a programmable delay and are listed in this section. Some occur immediately, if the telephone to which you are directing a call is out of service or otherwise unavailable. These are listed with the descriptions of the features in which they occur.

Delayed Ring Transfer (DRT)

If no one answers a call within a programmable length of time, the system transfers the call to the Prime telephone.

Call Display information

If you have subscribed to Call Display services from your local telephone company, one line of information about an external caller is displayed after you answer. If your telephone has been programmed to receive Call Display information automatically, that information is shown before you answer. If your telephone has not been programmed to receive Call Display information automatically, you can use the Call Information feature (Feature) to view the information before you answer.

Depending on the setting in Administration Programming and the external information available, either the caller's name or telephone number is displayed. When you transfer an external call to another Norstar user, this information is displayed on the recipient's telephone.

There will be a delay between the time your telephone first rings and when Call Display information is available. If you answer a call before the Call Display information arrives, that information is not available for the call. Since Call Display information arrives by the second ring, you can ensure that Call Display information is available by answering the call after the second ring.

Related features

Call Pickup

Call Pickup lets you use your telephone to answer a call that is ringing at someone else's telephone.

Call Queuing

Call Queuing allows you to choose the call with the highest priority when you have more than one call ringing at your telephone.

Do Not Disturb

Feature 8 5

If you do not wish to receive calls, turn on Do Not Disturb.

Handsfree/Mute

Handsfree

You can answer calls without picking up the receiver using Handsfree/Mute.

Prime telephone

A Prime telephone receives calls that go unanswered at other telephones. For more information, see Special telephones.

Retrieving a Parked Call

You can retrieve a parked call at any telephone in the system.

Voice Call Deny

Feature 8 8

If you do not wish to receive voice calls, turn on Voice Call Deny.

What line indicators mean

▶ Flashing on and off for equal lengths of time	There is an incoming call on the line.
▶ Flashing on and off more quickly	You have placed a call on hold.
▶ Flashing on for longer than off	Someone else has put a call on hold on that line.
▶ On, not flashing	You are connected to the call on that line or the line is in use elsewhere.
Off	The line is free.

Rings you may hear

A double beep every ten seconds	A call has been camped to your telephone.
A long single ring	There is an external call on the line for you.
A shorter double ring	There is an internal call on the line for you or a call is being transferred to you.
A brief single ring	A call is being redirected on one of your redirected lines. You cannot answer this call. See Line Redirection.
Three beeps descending in tone	You are receiving a priority call.

Displays

You will see one or more of the following displays when you receive a call on your telephone and while you are answering that call. See Messages for a full explanation of the Messages feature. See Dialing for a full explanation of Ring Again.



This indicates a long distance call.



You are connected to an internal call. You can press TRANSFER to transfer the call.

22>21

Either you are receiving an internal call from telephone 22 forwarded by telephone 21 or you have an Answer button for telephone 21 and an internal call from 22 is ringing on 21.

21 calling

You are receiving a call from telephone 21.

Call 21?
YES NO

You have received a Ring Again offer for a call to an internal telephone. To call the number again, press YES or the flashing internal line button. On the M7100 Telephone, just lift the receiver. Otherwise, press NO or wait 30 seconds for the Ring Again offer to expire. For an explanation of Ring Again, see Dialing.

Camped: 21
CALLBACK

The person to whom you camped the call did not answer it. The call has come back to you. Press the CALLBACK button or the line button to reconnect to the call.

Line 01
TRANSFER

You are connected to an external call. You can press TRANSFER to transfer the call.

Line 01 transfer

The call on line 01 is being transferred to you by someone else in your Norstar system.

Line 01>21

Either you are receiving an external call forwarded from telephone 21 or you have an Answer button for telephone 21 and an external call is ringing on that telephone.

No calls waiting

You tried to use Call Queuing but no call was ringing at your telephone.

No line selected

There is no call ringing at your telephone. If you have a flashing line button but your telephone is not ringing, you must press the line button to answer the call on that line.

Not in service

The telephone to which you have directed a call is not in service or is otherwise unavailable. The call is returned to your telephone.

**Parked call
CALLBACK**

Nobody answered the call you parked. The call has come back to you.

Pick up receiver

You have used the Call Queuing feature without picking up the receiver and Auto Handsfree has not been assigned to your telephone. You must use the receiver or **Handsfree** to answer a ringing call.

**Priority>21
BLOCK**

You are receiving a Priority Call. If you are on another call, inform the person you are speaking to that the call is about to be put on hold. Press the flashing line indicator of the Priority Call or wait till the call connects automatically (in eight seconds). The Priority Call goes through when you hear the next beep. Your active call is placed on Exclusive Hold. It will be reconnected automatically when the priority call ends unless you transfer the priority call. If you transfer the priority call, you must press the line button of your original call to reconnect. (For the M7100 Telephone, you must hang up the receiver to complete the transfer and then pick up the receiver and press **Hold** to reconnect.) To reject a Priority Call, use DND (**Feature** **8** **5**) or press **BLOCK**.

Release a call

You have no free line buttons on which to receive a call. Release one of your current calls and try again to answer the incoming call.

Use line pool?
YES NO

You have received a Ring Again offer for a line pool. To use the line pool, press YES or the flashing internal line button. On the M7100 Telephone, just lift the receiver. Otherwise, press NO or wait 30 seconds for the Ring Again offer to expire. For an explanation of Ring Again, see Dialing.

Prime telephone displays

If yours is a Prime telephone, you may see the following displays:

DND from 23

The person at telephone 23 has routed an external call to you using Do Not Disturb while the call was ringing.

DND transfer

The system has routed an external call to you from a telephone placed in Do Not Disturb to prevent calls from ringing.

DRT Line 01

Nobody answered this call on line 01, so the system routed it to you.

Held by KAREN

Karen has held a call for too long, so the system has routed it to you.

Line 01 callback
CALLBACK

Someone has camped, parked or transferred a call on line 01, but no one has answered it. Press the CALLBACK button or the line button to connect to the call.

Line 01 to prime

There is no telephone that can receive a call on line 01, so the system has routed it to you.

Notes

There are three indications of an incoming call: ringing, a line button flashing, and a message on the display. You will not necessarily receive all three indications for any particular call. You may have a line that has been set up not to ring at your telephone. If so, you will see only a flashing line button. If someone makes a voice call to you, you will hear a beep followed by their voice. There are many possible combinations, depending on how your system is set up. See Lines in the System features section for more information on the use of lines.

There are many ways to answer a call. Many of them depend on settings in Administration programming. Depending on various settings and the type of call you are receiving, you may be able to answer a call by: picking up the receiver, picking up the receiver and pressing a line button, pressing , pressing and pressing a line button, pressing a line button, or simply speaking.

If you receive a Priority Call and your telephone has no free internal line buttons, you cannot transfer the call or do anything else with it, except release it.

On M7100 Telephones, you may answer a second call by pressing . Your active call is put on hold and you are connected to the waiting call. You can have no more than two calls at a time.

Autodial

You can program memory buttons for one-touch dialing of internal or external telephone numbers.

External Autodial

Feature * 1

1. Press Feature * 1 .
2. Select the button you want to program. This is not necessary for the M7100 Telephone.
3. If you want this autodialer to use a particular line or line pool, select that line or line pool button. On the M7100 Telephone, you can only select a line pool button.
4. Enter the number.
5. Press **OK** or Hold .

Internal Autodial

1. Press Feature * 2 .
2. Select the button you want to program. This is not necessary for the M7100 Telephone.
3. Enter the number.

Displays

You will see some of the following displays while programming an Autodial button. See Dialing for displays that may occur while using an Autodial button.

987_
QUIT BKSP OK

Continue to enter digits until the number is complete. Press **BKSP** or ⇒ to erase an incorrect digit. Press **OK** or Hold when you are finished.

Autodial full

The memory allotted to Autodial numbers in your Norstar system is full.

Button erased

While programming External Autodial, you pressed **OK** or **Hold** before entering any digits. This erases the button.

Enter digits
QUIT OK

Enter the number you wish to program exactly as you would if you were dialing it yourself.

Hold or release

You cannot program an Autodial button while you are on a call. Finish your call or place it on hold before programming an Autodial button.

Intercom #: _
QUIT

Enter the internal telephone number you wish to program.

Press a button
QUIT

Press the memory button you want to program.

Program and HOLD

Enter the number you want to program onto the button, then press **Hold**. You may include a line or line pool selection in an autodial sequence by selecting the line before entering any digits.

Program and OK
QUIT OK

Enter the number you want to program onto the button, then press **Hold** or **OK**. You may include a line or line pool selection in an autodial sequence by selecting the line before entering any digits.

Programmed

The number is stored on the button.

Notes

If the power to your Norstar system is off for more than three days, Autodial numbers may be lost from the memory.

Autodial numbers must be programmed onto memory buttons. They can not be programmed onto external or internal line buttons, the Handsfree/Mute button, or Answer buttons.

You can program Host System Signaling codes as part of a number on an External Autodial button. See Host System Signaling.

If you do not include a line selection in an autodialer, the call will use your Prime line, if you have one. If you select a line before pressing the Autodial button, any line selection programmed onto the button will be ignored.

You can copy the telephone number from a Last Number Redial button or Saved Number Redial button onto an Autodial button. Simply enter the Last Number Redial feature code or Saved Number Redial feature code when the Autodial feature asks you to enter a number.

You can use the Button Inquiry feature to check the numbers programmed on your autodial buttons.

Call Forward

Feature 4

Forward your calls

You can have all your calls forwarded to another telephone in the Norstar system.

1. Press Feature 4 .
2. Enter the number of the internal telephone to which you want your calls forwarded.

Forwarding remains in effect until you enter the Cancel Call Forward feature code.

Cancel Call Forward

Feature # 4

You can start to receive calls again.

1. Press Feature # 4 .

Call Forward on Busy

Call Forward on Busy redirects calls to another telephone when you are busy with a call. The System Coordinator sets up Call Forward on Busy in Administration programming.

Call Forward (No Answer)

Call Forward (No Answer) forwards unanswered calls to another telephone. The System Coordinator sets up Call Forward (No Answer) in Administration programming.

Call Forward Override

You can call someone and ask them to stop forwarding their calls to you.

1. Dial that person's number and ask them to cancel call forwarding. Your call will ring at that person's telephone even though they are forwarding their calls.

Related features

Do Not Disturb

Feature 8 5

You can use the Do Not Disturb feature to forward your calls to the Prime telephone.

Line Redirection

Feature

Note the differences between Line Redirection and Call Forward. Call Forward forwards all calls that arrive at a particular telephone to another telephone within the Norstar system. Line Redirection redirects only the lines you specify, no matter which telephones they appear on, to a telephone outside the Norstar system.

Displays

You will see some of the following displays while forwarding your calls. See Do Not Disturb for a full explanation of that feature. See Answering the telephone for displays that occur when a telephone receives a call forwarded by another telephone.

Forward denied

You cannot forward calls to the number you have chosen. There are several reasons why this can happen. For instance, you cannot forward your calls to a telephone that has been forwarded to your telephone.

Forward to:

Dial the internal number or press the Internal Autodial button of the telephone to which you want your calls to be forwarded.

**Forward>21
CANCEL**

Your calls are being forwarded to telephone 21. Press the **CANCEL** button or when you want to stop forwarding your calls.

Not in service

Two or more telephones are linked in a forwarding chain, and one of them is out of service or is being used to program the system.

Notes

When a call is forwarded, it does not ring but its line indicator still flashes on your telephone. You can answer the call by pressing the button next to the flashing indicator.

If the telephone to which you forwarded your calls does not have the same external lines as your telephone, the forwarded calls appear on internal line buttons.

Telephones that have Call Forward on Busy active can still receive Priority calls.

Call Forward on Busy does not forward camped calls.

When Call Forward is active, all calls go to the Call Forward destination, regardless of the Call Forward on Busy and Call Forward no Answer settings.

Calls that are redirected by Line Redirection are not affected by any of the Call Forward features.

Call Information

Feature 8 1 1

Call Information allows you to display information about incoming calls. This information is more detailed than the Call Display information you automatically receive. See the Answering the telephone section in this chapter for details. For external calls, you can display the caller's name, telephone number, and the line name. For an internal call, you can display the name of the caller and their internal number. You can obtain information about ringing, answered, or held calls.

Note: Names and numbers for external callers are displayed only if you have subscribed to Call Display services from your local telephone company.

Display Call Information before or after answering

1. To find out who is calling or to obtain information about your current call, press Feature 8 1 1 .
2. If the call is an internal call, the caller's name and the internal number are displayed.

OR

If the call is an external call, incoming call information may be available.

To obtain more information about an external call:

For a one-line display, press # repeatedly to display more information about the call.

OR

For a two-line display, continue to press VIEW to display more information about the call.

Display Call Information for a call on hold

1. To obtain information about your held call, press

Feature .

2. The display shows ▶**Select a call.**
3. Select the line on hold.
4. If the call is an internal call, the caller's name and internal number are displayed.

OR

If the call is an external call, the caller's name is displayed.

To obtain more information about an external call:

For a one-line display, press repeatedly to display more information about the call.

OR

For a two-line display, continue to press VIEW to display more information about the call.

Related features

Call Log

Call Log displays the same information as Call Information, along with the date and time of the call, and the number of times the caller called.

Displays

▶5551234
EXIT VIEW

You would see this display if you were on an active call with a caller at 555-1234.

▶55551234
EXIT VIEW

You would see this display if you were on an active long distance call with a caller at 555-1234.

Note

Call Display information becomes available between the first and second ring of an alerting call. If you answer before the Call Display information is available on your display, and you press

Feature , you will only see the line number or line name.

Call Log

Call Log creates a list of records of incoming external calls. The log could contain the following information for each call:

- sequence number in the Call Log,
- name and number of caller,
- indication if call was long distance,
- indication if call was answered (and identification of who answered it),
- time and date of the call,
- number of repeated calls from the same source, and
- name of the line that the call came in on.

Call Log has many benefits. For example, you may find it helpful to :

- keep track of abandoned or unanswered calls,
- call back a customer who was unable to reach anyone,
- track patterns for your callers (for example volume of calls and geographical location of calls),
- record caller information quickly and accurately, and
- build a personal telephone directory from log items.

Note: Names and numbers for external callers are displayed only if you have subscribed to Call Display services from your local telephone company.

Choose Logging Options

Feature * 8 4

You can select the type of calls that will be stored in your Call Log.

1. Press * 8 4 .
2. If the default has not changed, the display shows **No one answered**. If you want to log calls that were not answered, press **OK** or **OR** Press **NEXT** or to display the next selection.
3. The display shows **Unanswered by me**. If you want to log calls that were unanswered at your telephone but answered elsewhere in the system, press **OK** or **OR** Press **NEXT** or to display the next selection.
4. The display shows **Log all calls**. If you want to log all calls, answered and not answered at your telephone, press **OK** or **OR** Press **NEXT** or to display the next selection.
5. The display shows **No autologging**. If you do not want information to be automatically logged, press **OK** or **OR** Press **NEXT** or to return to the first selection.
6. To exit, press .

Use Logit (manually log a call)

Feature 8 1 3

If your calls are not automatically logged, Logit lets you manually log call information when you are connected to an external call. Being able to store information for your current call can be helpful in many situations. For example, you may want to:

- record a caller's information without using paper and pencil,
- record only selected calls that you personally choose, as opposed to using Call Log automatically, and
- quickly record caller information before a caller hangs up.

To manually log an external call:

1. Press .

OR

Press a memory key programmed with this feature code.
(See the Feature programming section in this chapter.)

Use Autobumping

Since your log has a set number of entries that it can hold, Autobumping is a feature that lets you tell Norstar what to do when your log becomes full. When Autobumping is on, a new log entry causes the first entry to be deleted. If Autobumping is off, your Norstar system will not log new calls when your log is full.

1. To turn Autobumping on, press .

OR

To turn Autobumping off, press .

Enter Call Log

You can enter your Call Log to view stored information. The Log may display special characters. These are described in detail in the description of Displays, later in this section. To view your log:

1. Press .

2. The display shows the number of previously read items (Old) and the number of new, unread items (New) in the log.

3. To view old items, press OLD or .

OR







To view new items, press NEW or .

OR

To return to the item being viewed when you last exited the log, press RESUME or .



Navigate within Call Log

You can navigate within your Call Log to view a particular log entry. You can also scroll within an entry itself.



1. To scroll through an entry, press **MORE** or    **OR**
To view the next entry, press **NEXT** or .
OR
To go back to the previous entry, press .
2. To exit, press .

Erase Log Items

It is necessary to routinely erase read log items to make space for new items in your log.

1. Navigate to the item you want to erase.
2. Press **ERASE** or .
3. To exit, press .

If you accidentally erase an item, you can undo the erasure.

1. Immediately after accidentally erasing an item, press **UNDO** or .
2. To exit, press .

Call from Call Log

You may find it helpful to place calls from within your Call Log. Each stored caller number may vary according to the information associated with that particular call. If the caller number involves a Centrex or PBX system, the first few digits may need to be "trimmed" to make the caller number dialable. If the number that you want to call is long distance or uses line pool access, digits may need to be added to the beginning of the number.

Place a call



1. Navigate to the log item for the number that you want to dial.
2. Display the number and edit it if necessary to make it dialable (the instructions for adding or trimming digits follow).
3. Press an external line or line pool button.
4. Lift the receiver. This is not necessary if Handsfree is programmed at your telephone.
5. The displayed number is dialed.

Trim a number involving Centrex or PBX

To trim the caller number:

1. Press **TRIM** or ⇒  , once for every digit that you want to remove.

Add digits for long distance or line pool access

1. Add digits to the number by pressing the appropriate dial pad digits, just as you would do to dial.
2. To remove digits you have added, press **BKSP** or ⇒  , once for every digit that you want to remove.

Optional Password

You have the option of accessing your Call Log through a password. If you forget your password, there is a facility in Administration programming to clear it (and then you could enter a new password from your telephone).

Assign a password to your Call Log

1. Press * 8 5 . The display shows
New Password: _.
2. Enter your four-digit password. The display shows
Repeat New: _.
3. Re-enter your four-digit password. The display shows
Password changed, which confirms that your password has been assigned.

Using your Password to enter Call Log

1. Press 8 1 2 to enter Call Log.
2. If you have programmed a password, Password: _ appears.
3. Enter your four-digit password.

Change your password

1. Press * 8 5 . The display shows
Old Password: _.
 2. Enter your old password. The display shows
New Password: _.
 3. Enter your new four-digit password. The display shows
Repeat New: _.
 4. Re-enter your password. The display shows
Password changed, which confirms that your password has been changed.
-

Delete an assigned password

After assigning a password to your Call Log, you may later decide that you do not want to use a password at all.

1. Press **Feature** * **8** **5**. The display shows
Old Password: _.
2. Enter your old password. The display shows
New Password: _.
3. Press **OK** or **Hold**. The display shows
No Pswd assigned, which confirms that your password has been deleted.

Related features

Call Information

The same Call Display information as in Call Log is displayed, but it is not recorded in a log.

Displays

You will see some of the following displays as you use Call Log.

```
12:KATE SMITH
NEXT ERASE MORE
```

This is a Call Log item with its sequence number. When the first digit is underlined, it is a new item.

```
12)KATE SMITH
NEXT ERASE MORE
```

This indicates that the call was answered.

```
12SKATE SMITH
NEXT ERASE MORE
```

This indicates a long distance call.

```
49/1234567890123
NEXT ERASE MORE
```

The "slash" symbol (/) indicates that the displayed information for a call has been truncated. Press **MORE** to display the remaining digits

```
Jan 4 9:00a 3X
NEXT ERASE MORE
```

This is the repeat call counter, shown along with time and date display. It indicates the number of calls you have received from the same caller.

```
Autobump ON
```

The Autobumping feature is active.

Autobump OFF

The Autobumping feature is deactivated.

Call(s) bumped

One or more calls have been autobumped.

Call for you

There is one new item in the Call Log.

Calls for you

There are two or more new items in the Call Log.

Call logged

The call was successfully logged with Logit.

Hold or release

Your active call must be held or released before entering Call Log.

In use: SETNAME

The external line is in use.

Item erased
OK UNDO

The item was erased from the Call Log.

LINE 01 21
NEXT ERASE MORE

This display shows that this call was answered at telephone 21.

LINE 01 Logit
NEXT ERASE MORE

This display shows that this call was manually logged.

LINE 01
NEXT ERASE MORE

This display shows that this call was not answered.

Log is empty

Your Call Log is empty.

Log is full

No additional calls can be logged until you either turn Autobumping on, or you delete some items in your log.

Messages & Calls
MSG CALLS

This indicates that there are one or more items in your Message Waiting List, and that there are one or more new entries in your Call Log.

New calls begin

This appears before the first "New" item when navigating from the "Old" items to the "New".

No free lines	All lines in the pool are in use.
No info to log	No information is available on the call.
No log assigned	No log space has been assigned to the telephone.
No new items	There are no new calls in the Call Log.
No old items	There are no old or "viewed" items in the Call Log.
No resume item	The resume item is no longer in the Call Log due to Autobumping, repeat call update, or log reallocation.
Private name	The caller's name is private.
Private number	The caller's number is private.
Release calls	The active call must be released before entering Call Log.
1:Unknown call	The caller's name and number are unknown.
1:Unknown name	The caller's name is unavailable.
1:Unknown number	The caller's number is unavailable.

Notes

You may want to use the punch-out overlay, which is provided in the *Call Log Feature Card*. This card is available in a separately orderable Call Display Key Cap Kit. Please contact your Customer Service representative.

The default log size is zero items. This size can be changed in Administration programming.

The long distance indicator may not be shown in the log, depending on the Call Display services provided by your local telephone company.

For tips on programming Call Logs, see the Call Display services section in the Welcome to Norstar chapter.

Call Park

Feature 7 4

Park a call

You can suspend a call so that it can be retrieved from any telephone in your system.

1. Press Feature 7 4.
2. Use the Page feature to announce the retrieval code displayed by your telephone.

Retrieving a parked call

1. Select an internal line.
OR
If you have an M7100 Telephone, pick up the receiver.
2. Dial the call park retrieval code.

Displays

You will see some of these displays while parking a call. You may see some of these displays while retrieving a parked call.

Already Parked

The person you were talking to has already parked your call. You both cannot park the same call.

Get call first

The call you wish to park is on hold and you must reconnect to it before you can park it.

Invalid number

You have entered an invalid retrieval code.

No call on: 102

There was no call on the retrieval code you entered.

No call to Park

You have attempted to park a call, but there are no calls at your telephone.

Park denied

You have tried to park a conference call. Split the conference and park the calls separately. The person who retrieves the calls can reconnect the conference.

Parked on: 102
PAGE EXIT

Record the code shown. Use Page () or press **PAGE** to announce the call and its retrieval code.

Parking full

Both available retrieval codes are in use. Transfer the call or take a message instead.

Notes

When you park a call, the system assigns one of two codes for the retrieval of the call. These codes consist of the Call Park prefix, which may be any digit from 0 to 9, and a two-digit call number 01 or 02. For example, if the Call Park prefix is 1, the second parked call is assigned the call park retrieval code 102.

Your Customer Service representative sets the Call Park prefix in Configuration programming. If the Call Park prefix is set to None, parking is disabled.

Your Customer Service representative also sets the Call Park Callback delay in Configuration programming. External calls parked for longer than the program delay are returned to your telephone.

Call Pickup

You can pick up a call that is ringing at another telephone.

Directed Pickup

Feature 7 6

You can answer any telephone that is ringing in your Norstar system

1. Press Feature 7 6.
2. Enter the internal number of the ringing telephone.

Group Pickup

Feature 7 5

Your Norstar system can be divided into as many as four pickup groups. If you are a member of a pickup group, you can pick up a call that is ringing at any telephone in your pickup group.

1. Press Feature 7 5.

Trunk Answer

Feature 8 0 0

The Trunk Answer feature allows you to answer an external call that is ringing at any other telephone in your office.

Trunk Answer works only with calls that are ringing on lines for which a Service Mode is active and if Trunk Answer is on in Administration programming.

1. Press Feature 8 0 0.

Displays

You may see some of these displays while using a Call Pickup feature.

Already joined

You are already connected to the telephone that made the call you are trying to pick up. This can happen if you are on a call to a co-worker, your co-worker dials the number of a telephone in your pickup group, and you attempt to pick up that call.

Denied in admin

Your telephone is not a member of a pickup group.

No button free

You have tried to pick up a call when you have no line button available.

Pickup denied

(Pickup) There is no call that you can pick up or the call that was ringing has already been answered.

(Trunk Answer) The call that is ringing is on a line that is not in a Service Mode.

You have attempted to pick up a call on someone else's private line.

Pickup:

Enter the internal number of the telephone that is ringing. (You may use an Internal Autodial button to do this.)

If you decide not to answer a ringing call once you have activated Directed Pickup, press . The call will continue to ring.

Notes

Call Pickup cannot be used on private lines.

To use Directed Pickup, the telephone must be ringing. If, for example, the auxiliary ringer is ringing, but the call is not ringing at a telephone, the call cannot be answered using Directed Pickup. It must be answered normally at a telephone that has a flashing indicator for the call, or by using Trunk Answer.

If a call is ringing on an Answer button you can use Directed Pickup to answer the call by entering the internal number of any member of the Answer group.

If there is more than one incoming call at a telephone in a pickup group, a call ringing on the Prime line is answered first followed by calls on external lines and, finally, calls on internal lines.

If there is more than one incoming call on lines in a Service Mode, the Trunk Answer feature picks up the external call that has been ringing the longest.

The System Coordinator can assign telephones to one of four pickup groups in Administration programming.

Call Queuing

Feature 8 0 1

When you have more than one call ringing at your telephone, you can choose the call that has the highest priority.

1. Press Feature 8 0 1 .
2. The system connects you to the call that has the highest priority.

Notes

Call Queuing answers external incoming calls before callback calls, and answers callback calls before camped calls.

Call Queuing can be programmed onto a memory button.

Camp-On

 Feature

Camp a call

You can send an external call to another telephone, even if all its lines are busy.

1. Press .
2. Dial the number of the telephone you want to camp the call on.

Related features

Transfer

 Feature

Camp-On is a variation of the Transfer feature.

Displays

You will see some of the following displays while camping a call.

21 CAMP max
CALLBACK

You tried to camp a call to a telephone that already has a camped call. The call has come back to you. Press the CALLBACK button or the line button to reconnect to the call. On the M7100 Telephone, just pick up the receiver.

21 DND
CALLBACK

The person to whom you redirected a call has Do Not Disturb active on the telephone. The call has come back to you. Press the CALLBACK button or the line button to reconnect to the call. On the M7100 Telephone, just pick up the receiver.

Camp denied

You have tried to camp an internal call. You can only camp external calls.

Camp to:
CANCEL

Dial the number of the internal telephone to which the call will be sent.

Camped: 21
CALLBACK

The telephone to which you camped a call did not answer the call. The call has come back to you. Press CALLBACK or the line button to reconnect to the call. On the M7100 Telephone, just pick up the receiver.

Line 01 hung up

A call you camped has come back to you, but the caller hung up before you could reconnect.

Make call first

You have no call to camp. If the call you want to camp is on hold, take it off hold and then camp it.

Not in service
CALLBACK

The telephone to which you have camped a call is out of service or is being used for Configuration or Administration programming. The call has come back to you. Press CALLBACK or the line button to reconnect to the call. On the M7100 Telephone, just pick up the receiver.

Release a call

The line that the camped call is on is in use or that line does not appear at your telephone. Release the line or release an internal line.

Notes

To answer a camped call, use Call Queuing or select a line if the camped call appears on your telephone.

If you use Call Queuing to answer a camped call, external calls and callback calls are answered before the camped call.

Camped calls appear on a line button on the receiving telephone, if one is available. If not, there is just a message on the display and Camp tones.

Conference

Feature 3

Create a conference

You can talk to two people at once.

1. Make sure you have two calls, one active and one on hold.
2. Press Feature 3 .
3. Take the held call off hold (this is automatic on the M7100 Telephone).

Conference using Privacy

Feature 8 3

Normally your calls are private; no one else can pick up your line and join in your conversation. You can turn Privacy off for a call allowing another person with the same line to press the line button and join in your conversation, forming a conference.

1. Press Feature 8 3 .
2. Tell the other person to press the line button and join your conversation.

Disconnect one party

You can disconnect one party from a conference and continue talking to the other.

1. Press the line button of the call that you want to disconnect. The call that you want to keep is automatically put on hold.

OR

For the M7100 Telephone, press Feature # 3 , which places one party on hold. Press Hold again if necessary, to put on hold the party that you want to keep.

2. Press Rls . The call is disconnected.
 3. To speak to the remaining party, press the line button of the held call, or for the M7100 Telephone, press Hold .
-

Independently hold two calls

For all Norstar telephones except the M7100 Telephone, you can put the two people on hold independently so that they cannot talk to each other.

1. Press the line button of one person. The other person is automatically put on hold.
2. Press . The second person is put on hold.

You can re-establish the conference.

1. Take one call off hold.
2. Press .
3. Take the other call off hold.

Put a conference on hold

You can put a conference on hold, allowing the other two people to continue speaking to each other.

1. Press . The indicators beside the held line buttons flash, or for the M7100 Telephone, the display shows **Conf. on hold**.

You can reconnect to the conference.

1. Press either of the held line buttons, or for the M7100 Telephone, press . You are reconnected.

Split a conference

You can talk with one person while the other person is on hold.

1. Press the line button of the person you want to speak to. The other person is automatically put on hold.

OR

For the M7100 Telephone, press # , which puts the first party on hold. Press again if necessary to switch parties.

You can reestablish the conference.

1. Press .
2. Take the held call off hold. This is not necessary for the M7100 Telephone.

Related feature

Unsupervised Conference

Feature 7 0

You can permanently disconnect yourself from the conference and leave the other two people talking by pressing (Feature 7 0). However, if both of the other people are outside the system, there are some restrictions: at least one of the outside callers must have called you and that call must be on a disconnect supervised line.

Displays

You will see some of these displays while using the Conference feature.

3 parties only

You are trying to add a fourth party to your conference call, or to join two conferences together. Release one call from the conference before adding another, or keep the two conferences separate.

Access denied

Privacy control cannot be used on internal or conference calls.

Conf. on hold

You have put a conference call on hold.

Conference busy

You have tried to make a conference call, but your system is already handling its maximum number of conference calls.

Line 01 21
TRANSFER

You are on a conference with the two lines or telephones shown. You can drop out of the conference and leave the other two parties connected (Unsupervised Conference) by pressing **TRANSFER** or entering the Transfer feature code.

Make calls first

You have tried to set up a conference call, without having made the calls that are to be connected. Make both calls first.

Make call first

You have tried to use Privacy Control when you are not on a call.

Make second call

You have tried to set up a conference call while connected to only one caller. Put your first call on hold, make a second call, and enter the Conference feature code again.

No button free

You have put a conference call on hold, then tried to get another line. Your telephone can handle only two lines at a time, and your conference call is using both of them.

No free lines

You have put a conference call on hold, then tried to get another line. Your telephone can handle only two lines at a time, and your conference call is using both of them.

Press held line

You have activated the Conference feature with one call active and another on hold. Press the line of the call on hold to bring that person into the conference.

Notes

Only the person who established the conference can process the conference in any of the ways just described.

The Conference feature supports only three people.

If you are using an M7100 Telephone:

- Your conference is connected as soon as you enter the Conference feature code. There is no need to take the second call off hold.
- To split a conference, press # . Then, press to change from one caller to the other.
- You cannot independently hold two calls.
- You cannot join an existing two-party call to establish a Privacy conference although you can use the Privacy feature for calls at your telephone.

You cannot split a conference that was set up using Privacy. When a third person joins a conversation on a line that has Privacy turned off, the call becomes a conference. All the rules applicable to a conference apply except that there is only one-line in use, instead of the normal two.

In certain situations, you may experience lower volume levels when using the Conference feature with two external calls.

COS Password

Feature 6 8

Change your Class of Service

A Class of Service password is a six-digit code that lets you switch from your current Class of Service to one that lets you dial numbers prohibited by your current Class of Service.

1. Press Feature 6 8 .
2. Enter your COS password.

Displays

You will see the first of these displays when entering a COS password, you may also see the second.



(Blank display) Enter your password. It will not be shown on the display.

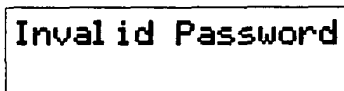

You have entered a password that is not programmed into your system.

Notes

You must enter a Class of Service password each time you wish to make a call using a Class of Service not normally available on your line or telephone.

Norstar allows up to 20 Class of Service Passwords.

The System Coordinator defines Class of Service passwords in Administration programming.

Customizing your telephone

You can change the way a telephone works in several ways. Some of the following features are assigned to telephones in Administration programming. You can turn other features on and off at individual telephones.

Automatic Handsfree

Automatic Handsfree lets you make or answer a call without having to pick up the receiver or press the button. The telephone's internal microphone and speaker turn on automatically when you make or answer a call.

The System Coordinator assigns Automatic Handsfree capability to a telephone in Administration programming. Full Handsfree capability must be assigned to a telephone before Automatic Handsfree capability can be assigned to it. This is also done in Administration programming.

This feature is not available on M7100 Telephones.

Contrast Adjustment

*

You can set the contrast level of your telephone display.

1. Press * .
2. Choose the contrast level you like best. The number of contrast levels available varies from one Norstar telephone to another.

This is the display you will see in Contrast adjustment.

```

Contrast level 2
DOWN  UP   OK
  
```

Press a number for the contrast level you want or press UP or DOWN. Press or OK to set the new contrast level.

Dialing Modes

Feature * 8 2

You can set the dialing mode of your telephone.

1. Press Feature * 8 2 .
2. Choose the dialing mode you want.

Norstar supports three dialing modes: Standard Dial, Automatic Dial, and Pre-Dial. All three modes support on-hook dialing. (On-hook dialing means dialing a call without picking up the receiver.) The special features of the Automatic and Pre-Dial modes are available only when you dial on-hook.

The Dialing Modes feature code cannot be programmed onto a memory button.

Standard Dial

In Standard Dial mode, you make a call by selecting a line and dialing the number. If you have a Prime line, it is selected automatically when you lift the receiver or press Handsfree .

Standard Dial does not support on-hook dialing on an M7100 Telephone. If you have an M7100 Telephone, use the Automatic Dial or Pre-Dial mode for on-hook dialing.

Automatic Dial

If you have a Prime line assigned to your telephone, Automatic Dial allows you to dial a number without selecting a line. Your Prime line is selected as soon as you start dialing a number. Automatic Dial does not work if your Prime line is in use.

Telephones connected to an Analog Terminal Adapter (ATA) cannot use Automatic Dialing.

Pre-Dial

Pre-Dial allows you to enter a telephone number, check it, then change it before actually making the call. The call is not dialed until you select a line or line pool, or pick up the receiver.

You can pre-dial both external and internal numbers. You must, however, select the correct type of line (external or internal) for the type of number you have entered.

If all the lines on your telephone are busy, you will not be able to enter a telephone number.

If your telephone starts ringing while you are pre-dialing a number, you can stop the ringing by turning on Do Not Disturb (Feature 8 5). This does not affect numbers you are entering.

This is the display you will see when selecting a Dial mode.

Standard dial	
NEXT	OK

The current dial mode is shown. Press # or NEXT until the dial mode you want appears. Press Hold or OK to select the displayed dial mode. If Automatic Dial is not available it is because you have no Prime line.

Language Choice

English

Feature * 5 0 1

You can select English as the language of your telephone display.

1. Press Feature * 5 0 1.

Alternate Language

Feature * 5 0 2

You can select the alternate language as the language of your telephone display.

1. Press Feature * 5 0 2.

Each Norstar system supports English and one alternate language. Norstar systems are available with either French or Spanish as the alternate language. Button caps are available in both alternate languages.

You can select either English or the alternate language at each telephone. When your system is first installed, all telephones will use English.

You can program a memory button for one-touch switching between languages. Program * 5 0 1 onto the button. Pressing the button will switch you back and forth between English and the alternate language.

* 5 0 2 cannot be programmed onto a memory button.

One of the following displays will appear when you enter a language choice feature code.

Telephone display messages will be in French.

Telephone display messages will be in Spanish.

Telephone display messages will be in English.

Move Line buttons

* 8 1

You can move external lines to different buttons on your telephone. You can use this feature to arrange your lines in the way that makes the most sense to you.

1. Press * 8 1.
2. Press the button you want to move the line from.
3. Press the button you want to move the line to.

You will see some of these displays while moving lines.

You have tried to move a line to a button that cannot be used as a line button, such as a Handsfree/Mute button, or an Answer button.

Press the button of the line you want to move. Press **QUIT** or when you have finished moving lines.

Press the button you want to move the line to. Neither of the buttons is erased. The lines, or the line and feature, simply switch places.

Press a line

The button you are trying to move is not a line button. If you are trying to switch a line and a feature, move the line to the feature button and not vice versa.

Pulse/Tone Dialing

Each external line is set to either pulse or tone dialing. Pulse dialing is the traditional method of dialing used by rotary dial or push button single-line telephones. Tone dialing allows telephones to communicate with other devices such as answering machines. Tone dialing is required to access the features that PBX systems may offer.

Your Customer Service representative sets your lines to pulse or tone dialing in Configuration programming.

To switch from pulse to tone dialing

#

If your external lines are programmed for pulse dialing, you can switch your telephone temporarily to tone dialing.

1. Press # while on an active line. Once you hang up, your telephone returns to pulse dialing.

Ring Type

Feature * 6

You can choose one of four distinctive rings for your telephone. This makes it easier to identify your telephone in an open office.

1. Press Feature * 6.
2. Choose the ring type you want.

This is the display you will see when choosing a ring type.

Ring type: 1
NEXT OK

Press **1**, **2**, **3**, **4** or **NEXT**. You hear the selected ring for two seconds. Repeat until you hear the ring you prefer, then press **Hold** or **OK**.

Ring Volume

Feature * 8 0

You can set the volume at which your telephone rings.

1. Press **Feature** * **8** **0**. The telephone will ring.
2. Press **Volume** to adjust the volume.

This is the display you will see while setting Ring Volume.

Press VOLUME bar

Press either side of the volume bar (**Volume**) to adjust the volume.

Related features

Autodial

Feature * 1 / Feature * 2

You can program your telephone's memory buttons to dial frequently used numbers with the Autodial feature.

Feature programming

Feature * 3

You can program feature codes onto your telephone's memory buttons using the Feature programming feature.

Speed Dial programming

Feature * 4

You can program Personal Speed Dial numbers onto Speed Dial codes 71 to 94 using the Personal Speed Dial programming feature.

Notes

Telephone Administration Lock is a system feature that is related to customizing your telephone. The System Coordinator assigns Administration Lock to each telephone in Administration programming.

Telephone Administration Lock limits the ways in which you can customize your telephone. There are three types of Telephone Administration Lock: Full, Partial, and None.

Full Administration Lock lets you change the contrast of your telephone's display, your Ring Type, your Ring Volume, use Button Inquiry, and control the volume of your speaker.

Partial Administration Lock allows you to forward your calls, turn on Do Not Disturb and Service Modes, and use the Background Music, Send Message, Ring Again, Privacy, and Trunk Answer features.

None (No Administration Lock) allows you to access all features that are programmed for your telephone.

Telephone Administration Lock does not affect call handling features.

Dialing

One of the most important features of your telephone system is the ability to dial telephone numbers. Many features require you to dial telephone numbers. The displays associated with dialing are listed here.

Direct-Dial

You can dial a Direct-Dial telephone with a single digit. The Direct-Dial telephone is usually in a central location, such as a receptionist's or secretary's desk. It is usually a Prime telephone with a Central Answering Position (CAP) module.

Your Customer Service representative assigns the Direct-Dial digit in Configuration programming.

External line access code

The external line access code is the number you dial to get an external line. You will need to use an external line access code if your Prime line is an internal line. The code will connect you to a line pool through your internal line.

If your Prime line is an external line, or if you select an external line on your telephone, you will not need an external line access code. You will always need an external line access code on an M7100 Telephone.

Your Customer Service representative assigns the external line access code in Configuration programming.

Last Number Redial

Feature

You can redial the last external number you dialed.

1. Press .

Ring Again

Feature 2

If you can't get through to someone on your Norstar system because their telephone is busy or there is no answer, you can have the Norstar system tell you when they hang up or next use their phone.

1. Press Feature 2 before you hang up.

You can also use Ring Again to tell you when a busy line pool becomes available.

Using Ring Again cancels any previous Ring Again requests at your telephone.

Cancel Ring Again

Feature # 2

You can cancel a ring again request by entering the Cancel Ring Again feature code.

Saved Number Redial

Feature 6 7

You can save the number of the external call you are on (providing you dialed the call) so that you can call it again later.

1. Press Feature 6 7 while you are still on the call.

You can dial a saved number.

1. Press Feature 6 7 when you are not on a call.

Related features

Autodial

Feature * 1 / Feature * 2

The autodial feature lets you program telephone numbers onto memory buttons for one-touch dialing.

Dialing modes

Feature * 8 2

Norstar supports three different methods of dialing. They are described in the Customizing your telephone section under the heading Dialing Modes.

Line Pools

Line pools give you access to many external lines.

Priority Call

 Feature

If you get a busy signal when you call someone in your office, you can interrupt them using Priority Call.

Speed Dial

 Feature

The Speed Dial feature lets you dial programmed numbers by entering Speed Dial codes.

Displays

You will see some of these displays while selecting lines and dialing telephone numbers and in response to the numbers you dial.

```
9_
QUIT BKSP
```

You are dialing using Pre-Dial. To erase an incorrect digit, press BKSP or \Rightarrow \Leftarrow . When the number is complete, select a line or lift the receiver.

```
21 busy
PRIORITY LATER
```

The telephone you have called has no internal lines available. You may press LATER to use the Ring Again or Message features or press PRIORITY to make a Priority Call.

```
95551234
TRANSFER
```

This prompt remains on your display as long as you are on a call you have dialed. You may transfer the call by pressing TRANSFER.

```
Already joined
```

Your telephone is already connected to the telephone you are trying to call. Check your active line buttons, and return to that call.

```
Calling 21
LATER
```

Wait for the telephone to be answered, or press LATER to use the Ring Again or Messages features.

```
Calling 21
PRIORITY LATER
```

Wait for the telephone to be answered. If no one answers, you may press LATER to use the Ring Again or Messages features, or press PRIORITY to make a Priority Call.

Can't ring again

You cannot use Ring Again on your current call. You can only use Ring Again while you have a busy signal on an internal call or line pool request or while an internal call is ringing.

Do not disturb
PRIORITY LATER

The telephone you are calling is in Do Not Disturb mode. Press LATER to use the Ring Again or Messages features, or press PRIORITY to make a Priority Call.

In use: 21

The line you have chosen is in use at another telephone. Use a different line, or wait until the line is free.

Invalid number

You have entered a number that does not exist.

Line denied

You have attempted to use someone else's private line.

Line in use

The line you have chosen is in use. Try another. If the line remains in use and never seems to clear, it may be hung. See Lines in the System features section for information on hung lines.

Line 01
TRANSFER

Enter the digits of the number you want to dial.

No button free

You have tried to make or receive a call when no line button was available.

No last number

You have not dialed an external telephone number since the last power interruption or system reset.

No line selected

Either you have no Prime line or your Prime line is busy. Select a line manually before dialing.

No number saved

You have tried to save the number of an incoming call. You can only save numbers that you have dialed yourself.

No saved number

You have tried to use Saved Number Redial, but have not first saved a telephone number. The Saved Number Redial memory is empty.

Not in service

You have entered the number of a telephone that is not in service.

On another call
PRIORITY LATER

The telephone you have called is on another call. Press LATER to use the Ring Again or Messages features, or press PRIORITY to make a Priority Call.

Restricted call

The call you are trying to make is not allowed for your Class of Service. Make your call on a line or telephone that is not restricted, or use a Class of Service password to bypass the restriction.

Ring Again?
YES NO EXIT

Press YES to use Ring Again. Press NO if you prefer to send a message. See Message and Ring Again.

Select a line

Either you have no Prime line, or the Prime line is in use, or the line programmed onto an Autodialer, Speed Dialer, or Hotline is in use. Select a line and dial again.

Send message?
YES NO

Press YES to send a message. See Messages.

Your number

You have dialed your own number.

Notes

The maximum number of digits that Last Number Redial or Saved Number Redial records is 24.

You can copy the telephone number from a Last Number Redial or Saved Number Redial button onto an Autodial button. Simply enter the Last Number Redial or Saved Number Redial feature code when the Autodial feature asks you to enter a number.

Each telephone can save only one number at a time with Saved Number Redial, not one number for each line.

telemanuals.com

Do Not Disturb

Feature 8 5

Do Not Disturb

You can stop calls from ringing at your telephone.

1. Press Feature 8 5.

Only Priority Calls will ring at your telephone. A line button will flash when you receive a call, but the call will not ring.

You can refuse to answer a particular call when it is ringing at your telephone. You can also refuse a Priority Call if all of the lines on your telephone are busy.

1. Press Feature 8 5.

Cancel Do Not Disturb

Feature # 8 5

You can cancel Do Not Disturb.

1. Press Feature # 8 5.

Displays

Do not disturb

Your telephone is in Do Not Disturb mode. To cancel Do Not Disturb, press Feature # 8 5.

Allow calls

Your telephone is receiving calls normally.

Note

If you use Do Not Disturb while an external call is ringing, the call will be forwarded to the Prime telephone. It may also be answered by anyone whose telephone shares the line it is on. Once you turn Do Not Disturb on, calls will be forwarded to the Prime telephone only if there is no other telephone on which the line appears. (The Delayed Ring Transfer feature transfers all unanswered calls to the Prime telephone after a specified time.)

Feature programming

Feature * 3

Program a button

You can program a feature code onto a memory button.

1. Press Feature * 3.
2. For all telephones other than the M7100 Telephone, select the button you want to program.
3. Enter the feature code you want to program onto the button.

Erase a button

Feature * 1

You can erase a memory button.

1. Press Feature * 1. This is actually the External Autodial feature code.
2. For all telephones other than the M7100 Telephone, select the button you want to erase.
3. Erase the button by pressing **OK** or Hold.

You cannot erase Answer, Handsfree/Mute, Intercom, or line buttons.

Button Inquiry

Feature * 0

You can check the function of any line, Intercom, or memory button on your Norstar telephone.

1. Press Feature * 0.
2. For all telephones other than the M7100 Telephone, press the button you want to know about.
3. Read the display.

When you are labeling or replacing a button cap, activate Button Inquiry so that you won't accidentally activate a feature.

Displays

You will see some of the following displays while programming, erasing, or checking buttons. A variety of displays appear in Button Inquiry. See the appropriate feature description in this chapter for a list of displays pertaining to the use of a feature programmed onto a memory button.

123456789012345..
VIEW→ OK

Press **#** to move either right or left, or press VIEW→ or ←VIEW to view a number that is too long to fit on the display. Press **Hold** or **OK** when you are finished.

<Feature name>
SHOW OK

The name of the feature assigned to a button is displayed when you press the button. SHOW appears when there is more information available. Press **#** or SHOW for additional information.

Enter code:

If you are checking a Speed Dial button, enter the two-digit Speed Dial code that you want to check.

Enter digits

To erase the button, press **Hold**.

F_
QUIT CLEAR

While entering a feature code you can press **Feature** or QUIT to quit programming or CLEAR to clear out the characters you have entered. The system will accept the entry as soon as you enter a valid feature code.

Feature code:
QUIT

Press **Feature** and enter the feature code you want to program onto the button. Invalid codes cannot be entered.

Feature moved

You have programmed a button with a feature that was already programmed onto another button. The feature has moved to the button you just programmed. Its original button is blank.

Hold or release

You cannot program a feature button while you are on a call.

Press a button
QUIT

Press the button you want to program the feature onto.

Press a button
EXIT

Press the button you want to check. Press or **EXIT** when you are finished.

Program and **HOLD**

To erase a button, press .

Program and **OK**
QUIT **OK**

To erase a button, press or press **OK**.

Release calls

You have tried to use Button Inquiry while you were on a call or had calls on hold.

Notes

When this Guide tells you to enter a feature code, you can do so by pressing a memory button programmed with that feature code. In some cases, pressing the button a second time cancels the feature.

On the M7100 Telephone, Button Inquiry shows your internal number followed by the function assigned to your single memory button.

Any memory button not programmed as an external or internal line, Answer button, or Handsfree/Mute button, is available for programming features.

The following feature codes cannot be programmed onto a memory button: any code beginning with except Language Choice and Contrast Adjustment.

Group Listen

 Feature 8 0 2

Group Listen

You can let people in your office listen in on a call.

1. Press Feature 8 0 2. You will hear the caller's voice through your telephone's speaker.
2. Continue to speak to the caller through the telephone receiver. The caller will not hear people in your office.

Cancel Group Listen

 Feature # 8 0 2

You can cancel Group Listen for the current call.

1. Press Feature # 8 0 2.

Group Listen is canceled automatically when you hang up the Group Listen call.

Displays

You may see one of these displays with Group Listen.

Make call first

You have tried to use Group Listen when you are not on a call.

Pick up receiver

You have tried to use Group Listen without picking up the receiver.

Notes

Keep the receiver away from the speaker, or you may hear feedback. The higher the volume, the more the feedback. Press the Ris button to prevent feedback when hanging up.

You can switch a Group Listen call to Handsfree by pressing Handsfree . To switch back to Group Listen, enter the Group Listen feature code again.

Handsfree/Mute

Handsfree

Make calls without lifting the receiver

You can make calls without lifting the receiver. However, you must have a Prime line assigned to your telephone.

1. Press

Handsfree

. The telephone's internal microphone and speaker are automatically turned on.
2. Dial your call.
3. Speak normally.

Answer calls without lifting the receiver

You can answer calls without lifting the receiver.

1. When your telephone rings, press

Handsfree

. The telephone's internal microphone and speaker are automatically turned on if you have a Prime line assigned to your telephone.
2. Speak normally.

Mute Handsfree

You can switch off the telephone microphone so that you can speak privately to someone in your office while you are on a handsfree call.

1. Press

Handsfree

. The microphone is turned off.

You can turn the microphone back on again and continue your handsfree call.

1. Press

Handsfree

.

Regular call to Handsfree

You can turn any regular call into a handsfree call.

1. Press

Handsfree

 and hang up the receiver.

Handsfree to regular call

You can turn a handsfree call into a regular call.

1. Lift the receiver.

Notes

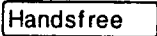
The indicator next to  is solid when you are in Handsfree mode. It flashes when you mute the microphone.

In open-concept environments, use the receiver or a headset when Handsfree communication is not necessary, or when you need privacy during a call. Always tell the person you are speaking to that you are using Handsfree, and let them know who else is listening to the conversation.

Direct your voice toward the telephone. The closer you are to the telephone, the easier it is for the microphone to transmit your voice clearly to your listener.

Wait for your caller to finish speaking before you speak. The microphone and speaker cannot both be on at once. Your caller's voice may be cut off if you both speak at the same time. Noises such as a tapping pencil could be loud enough to turn on your microphone and cut off your caller's speech.

To prevent a possible echo, keep the area around your telephone free of paper and other objects that might screen your microphone. Turning down the microphone's volume (using ) also prevents echo.

Place the telephone so that any unavoidable local noise (such as an air conditioner) is behind it. This limits the amount of disruptive background noise.

The System Coordinator assigns Handsfree to a telephone in Administration programming.

The Handsfree/Mute feature is not available on M7100 Telephones.

Hold

Put a call on hold

You can temporarily suspend a call.

1. Press .

When a call is on hold, its indicator flashes on all telephones that have access to the line. The call can be retrieved from any of these telephones.

Retrieve a held call

You can connect to a call on hold.

1. Press the flashing line button of the held call.

Automatic Hold

You can switch from one call to another.

1. Press the line button of the caller you want to speak to. Your current caller is put on hold automatically.

Listen on Hold

If you have been put on hold, you can hang up the receiver while you wait for the other person to return.

1. Press .
2. Hang up the receiver.
3. Press the line button of the call. (For the M7100 Telephone press). You may hear indications from the far end that you are on hold (for example, tones or music).
4. When the person you were talking to returns you will hear them through your telephone speaker. Lift the receiver and talk.

Exclusive Hold

Feature 7 9 or

Feature Hold

You can put a call on Exclusive Hold so that it can be retrieved only at your telephone.

1. Press Feature 7 9 or Feature Hold . The line appears busy on all other telephones, and the call cannot be picked up by anyone else in the office.

Music/Tones/Silence on Hold

External callers can hear either music, a periodic tone, or silence while they are on hold. In order for your caller to hear music, your company must have installed a music source.

WARNING

In accordance with U.S. copyright law, a license may be required from the American Society of Composers, Authors and Publishers, or a similar organization, if radio or TV broadcasts are transmitted through the Music on Hold feature of this telecommunication system.

Northern Telecom Inc. hereby disclaims any liability arising out of the failure to obtain such a license.

Your Customer Service representative sets this feature to music, tones, or silence in Configuration programming.

Notes

On the M7100 Telephone, Hold alternates between two lines: one active, one on hold. The M7100 Telephone cannot retrieve a call placed on hold by another telephone.

If the Automatic Handsfree feature has been assigned to your telephone, use the Handsfree/Mute feature instead of Listen on Hold.

Host System Signaling

You can access Host systems, such as Private Branch Exchanges (PBX) from Norstar by using Host System Signaling features (also known as End-to-End Signaling). These features either send a special signal to the host system or allow you to program delays required by host systems onto External Autodial buttons or Speed Dial codes.

Host system signaling codes

Link

Feature 7 1

If your Norstar system is connected to a Private Branch Exchange (PBX), you can use a Link signal to access special features.

The Link signal can also be included as part of a longer stored sequence on an External Autodial button or in a Speed Dial code. The Link symbol () uses two of the 24 spaces in a dialing sequence.

Pause

Feature 7 8

The Pause feature enters a 1.5 second delay in a dialing sequence on an external line. This is often required for signaling remote devices, such as answering machines, or when reaching through to PBX features or Host systems.

You can obtain a Pause with one button press if you program the feature code onto a memory button. More than one Pause can be programmed onto an External Autodial button.

The Pause symbol () uses one of the 24 spaces in a dialing sequence.

For Pulse Dialing, * inserts a 1.5 second pause into the dialing sequence.

Programmed Release

Feature * 8 9

The Programmed Release feature performs the function of the **Rls** button in a programmed dialing sequence. When the system encounters a Programmed Release at the end of a programmed dialing sequence, it hangs up the call after the numbers are dialed. The Programmed Release symbol (**RLS**) takes up two of the 24 spaces in a programmed dialing sequence.

Run/Stop

Feature * 9

Run/Stop inserts a break point into a sequence of dialed numbers or characters used for automatic dialing. This may be necessary when you are connecting to a PBX or similar Host system.

For example, you may call a company with an automated attendant that instructs you to dial the internal number you need. You can program the company number, a Run/Stop, then the internal number on one External Autodial button. Press the autodialer once to dial the company number. When you hear the automated attendant, press the autodialer again to dial the internal number.

The Run/Stop symbol (**RS**) uses one of the 24 spaces in an External Autodial or Speed Dial sequence.

Displays

You may see this display while entering Host System Signaling codes.

Invalid code

You have entered a code that can only be used in a programmed Autodial or Speed Dial sequence, not on a call you dial directly. Programmed Release and Run/Stop are for use in programmed dialing sequences only.

Note

If your external telephone lines are programmed for Pulse dialing, you can temporarily switch to Tone dialing by pressing after selecting the line. Tone dialing lets your Norstar telephone communicate with devices and services that respond to tone signals, such as automatic switchboards, and fax or answering machines.

telemanuals.com

Line Pools

 Feature 6 4

Use a line pool

A line pool is a group of external lines that can be shared by many telephones. You can use a line in a line pool to make an external call.

1. If you have a free internal line, dial a line pool access code on an internal line. (You do not need the Line Pool feature code.)

OR

If you have no free internal line, press Feature 6 4 and then a line pool access code.

Everyone in the office should have a list of the line pool access codes for the line pools their telephones can use. See the Programming reminders section in the Programming chapter.

Displays

You may see some of the following displays while using a line pool. For displays associated with dialing telephone numbers, see the Dialing section.

Code:	Enter a line pool access code.
Denied in admin	Access to the line pool you requested is denied in Configuration programming.
Invalid code	You have entered an invalid line pool access code.
Line in use	The line chosen by the system for your line pool request became active before connecting with your call. Retry the line pool request.
No button free	There is no free button on which the

No free lines

You have tried to access your line pool, but there are no lines in the line pool or all the lines are busy. Use Ring Again or call again later.

Notes

You do not usually need to enter the Line Pool feature code to use a line pool. Simply dial the line pool access code on an internal line. If you have no free internal lines, you will need to use the feature code to get a line pool. You will also need it to program access to a specific line pool onto a memory button.

You can program a button to access a line pool by programming the Line Pool feature code and a line pool access code onto a memory button in Feature programming (Feature * 3). When all the lines in a line pool are busy, the indicator for the Line Pool button turns on. The indicator turns off when a line becomes available.

Your Norstar system can have three line pools, and a telephone can be programmed to access any number of them.

You can use a line pool only to make external calls.

If no lines are available in the line pool, you can use Ring Again at the busy tone. You will be notified when a line in the line pool becomes available. See Ring Again.

Your Customer Service representative gives telephones access to line pools in Configuration programming. Each line pool is assigned a line pool access code in Configuration programming.

Line Redirection

Feature 8 4

Redirect a line

Line Redirection lets you send your external calls to a telephone outside the office. You may choose to redirect all your external lines or only some of them.

1. Press Feature 8 4 .
2. Select the outgoing line to be used for redirected calls.
3. Enter the number to which calls will be redirected and press **OK** or Hold .
4. Select the lines to be redirected and press **OK** or Hold .

Cancel Line Redirection

Feature # 8 4

You can cancel Line Redirection.

1. Press Feature # 8 4 .
2. Select the lines for which redirection is to be canceled and press **OK** or Hold .

Related features

Call forward

Feature 4

Note the differences between Line Redirection and Call Forward. Call Forward forwards all calls that arrive at a particular telephone to another telephone within the Norstar system. Line Redirection redirects only the lines you specify, no matter which telephones they appear on, to a telephone outside the Norstar system. Line Redirection takes precedence over Call Forward.

Displays while redirecting lines

You will see some of the following displays while programming Line Redirection. The displays you see while canceling redirection are listed after this chart. See the Dialing section for displays that occur while entering telephone numbers.

Access denied

You cannot perform line redirection on an M7100 Telephone.

Denied in admin

You have tried to redirect calls, but your telephone is not allowed access to this feature. See the Allow redirect section in the Programming chapter.

Enter digits
QUIT OK

Enter the telephone number to which you wish to redirect calls using one of the following methods:

- Press an External Autodial button.
- Enter an external telephone number of no more than 24 digits. Then, press or **OK**.
- Press or **OK** if the line you have chosen as the outgoing line is a private network line that does not require you to dial digits.

In use: 21

You have tried to program redirection while someone else is programming redirection. Only one person can program Line Redirection at a time.

Line Redirection
QUIT ADD REMOVE

Press or the **ADD** button to begin redirection. Press **REMOVE** or to cancel a previous redirection.

No line to use

You have one external line on your telephone, but you need a second line to perform line redirection. Redirect your external line using a line pool as the outgoing line.

Outgoing line

You are attempting to redirect a line and the line you have chosen is the outgoing line you have selected as a destination. You cannot redirect a line to itself. Select another line.

Pool code: _
QUIT

Enter a valid line pool access code.

Programmed

This message appears when you have successfully redirected a line or successfully canceled redirection of a line.

Redir by 21
OVERRIDE

You have attempted to redirect a line, but someone else has already redirected that line. You may press OVERRIDE or to override the previous redirection and redirect the line as you wish.

Restricted call

The destination you have chosen for line redirection is restricted.

Select line out
QUIT

Select the line that will be used to redirect calls out of the system, using one of the following methods:

- Press an external line button.
- Press an internal line button and dial a line pool access code.
- Press a line pool memory button.
- Press an External Autodial button if it has a line selection programmed.

Select line(s)
QUIT ALL

Press the lines that are to be redirected. To deselect a line, press it again. You may press ALL to redirect all your lines.

Select line(s)
ALL OK

Continue to press the lines that are to be redirected. Press OK or when you are finished.

Unequipped line

The line you are attempting to redirect cannot be redirected because it is not a disconnect supervised line. Your Customer Service representative assigns disconnect supervision to lines.

Displays while canceling redirection

You will see the following displays while canceling Line Redirection.

```
Redir by 21
OVERRIDE
```

This line is redirected by someone else. Press OVERRIDE or to cancel redirection of the line.

```
Select line(s)
QUIT ALL
```

Press the lines that are no longer to be redirected. The lines light up as you press them. Once you cancel redirection for a line you cannot restore it by pressing the line again. You may press ALL to cancel redirection for all your lines.

```
Select line(s)
ALL OK
```

Continue to press the lines that are no longer to be redirected. Press OK or when you are finished.

Notes

The Line Redirection feature is not available on the M7100 Telephone.

You can answer the telephone if it rings while you are in the middle of programming Line Redirection, but none of the Norstar call handling features will be available until the feature times out. If you need to use a Norstar feature to process the call, you must quit Line Redirection programming by pressing the button. **Do not press or you will disconnect the call you are trying to process.**

While you are programming Line Redirection you will only receive an indication of calls that actually ring at your telephone.

The system does not check that the number you give for line redirection is a valid one. If you redirect to an invalid number, redirection will fail. Using an External Autodialer to enter the redirection number helps avoid this possibility. An External Autodialer used for line redirection must have a specific line programmed onto it.

If you use the **ALL** button to redirect all your lines, it is important that you wait until all the lines on your telephone light up before pressing or **OK**. If you press or **OK** before all the lines light up, those lines not lit will not be redirected.

Be aware of the consequences of redirecting your lines. If you redirect your line to your home, for instance, and someone calls you from home, they will get a busy signal when the system tries to call the telephone they are using. Companies with offices in different time zones should avoid situations in which the lines from the eastern office are redirected to the west and those from the west are redirected to the east. This could result in a costly long distance redirection loop.

The system can be set up so that redirected calls give a brief ring on telephones in the Norstar system as they are redirected. These calls cannot be answered within the system until you cancel redirection.

The line chosen for redirecting calls on other lines can still be used normally when it is not busy on a redirected call. To avoid redirection failing because the chosen line is in use, choose a line pool with several lines in it.

When redirecting an external call to an external number, note the following restriction: the incoming call must be on a disconnect supervised line.

In certain situations, callers may experience lower volume levels when you use Line Redirection.

Long Tones

Feature

The Long Tones feature lets you control the length of a tone so that you can signal devices such as fax or answering machines which require tones longer than the standard 120 milliseconds.

1. While on a call, press .
2. Press the dial pad buttons to produce the appropriate tones. Each tone will sound for as long as you hold down the button.

Long Tones is canceled automatically when the call is released.

Displays

You will see some of the following displays while using Long Tones.

At the appropriate time, press any dial pad button. Hold each button down for as long as necessary. You can cancel Long Tones by pressing .

You have tried to use Long Tones when you are not on a call.

The person you are calling has pressed , canceling your long tones.

Note

Long Tones can be used on any call except a conference call. You can use internal lines of the Norstar system to activate a device connected to an Analog Terminal Adapter (ATA) in another area of your office, or external lines to access devices outside the Norstar system.

Messages

The Messages feature allows you to send a message to another Norstar user, and lets you know if you have any messages waiting. As well, the Messages feature uses a Message Waiting List to keep a record of your internal messages and your (external) voice mail messages, if the service is provided by your telephone company. From your Message Waiting List, you can:

- view your messages,
- call back the internal caller who left a message,
- erase an internal message,
- call your Voice Message Center that left a message(s), and,
- clear a message sent by your Voice Message Center (the message still remains at the Center until it is erased there).

Send a message

Feature 1

You can leave a message on the display of another telephone in your Norstar system.

1. Press Feature 1.
2. A one-line display shows **Message to:**
OR
A two-line display shows **Message list**. Press **ADD** to display **Message to:**
3. Enter the internal number that is to receive your message. Your recipient's display identifies that the message has arrived. –

Show your sent messages

Feature 1

On a telephone with a two-line display, you can show and scan the messages you have sent.

1. Press Feature 1. The display shows **Message list**.
2. Press **SHOW** to display your first sent message.

Cancel a sent message

Feature # 1

You can cancel a message that you have sent to someone.

1. Press Feature # 1. The display shows **Cancel for:**
2. Enter the internal number for the message that you want to cancel.

Notification of message(s)

If another user in your Norstar system or your Voice Message Center has sent you a message, your display reads **Message for you** or **Messages for you**. If you also have items in your Call Log, your display reads **Messages & Calls**.

Enter your Message Waiting List

Feature 6 5

To enter your Message Waiting List:

1. Press Feature 6 5. The display shows the first item.

Navigate through your Message Waiting List

To navigate forward through your list, press **NEXT** or #. To navigate backward, press *.

Call from your Message Waiting List

From your Message Waiting List, you can call the person (or your Voice Message Center) who sent the message. First, you may want to view your messages and decide if you want to reply to them.

1. Press Feature 6 5. The display shows the first message.
2. Press **NEXT** or # to scroll through the list of messages.
3. To call a particular number, press **CALL** or 0. The telephone number that is dialed to access your Voice Message Center is programmed in Administration programming. This telephone number is dialed automatically when you press **CALL** or 0.

If you wish to use a line other than the programmed line, exit from the Message Waiting List and dial the Voice Message Center telephone number using normal dialing methods.

Remove items from your List

Feature # 6 5

You can erase an internal message or clear a message you have received from your Voice Message Center. When you clear this message from your Message Waiting List, it still exists at your Voice Message Center until you erase it there. To erase a voice message, refer to your Voice Message Center documentation.

1. From an idle telephone, press Feature # 6 5 to erase or clear the first message (either an internal message or a message from your Voice Message Center).

OR

From within your Message Waiting List, press CLEAR or ERASE or Hold for the item that you want to remove.

Related features

Call Log

The status display for the Message Waiting List shares the same display with the Call Log status display.

Displays

You will see some of the following displays while sending messages.

1.21
NEXT ERASE EXIT

When reviewing the messages you have sent, press NEXT to view the next message or ERASE to erase the message on the display.

21 called
NEXT CALL ERASE

This is the Message Waiting List display for internal messages. Press NEXT to see the next message. Press CALL to reply to the message. Press ERASE to erase the message.

Can't send msg

You have tried to send a message to a Norstar Analog Terminal Adapter. The Norstar Analog Terminal Adapter does not have a display so it cannot show a message.

Cancel denied

You have entered an invalid number when attempting to cancel a message.

Cancel for:

Dial the internal number to which you sent the message you wish to cancel.

Cleared>LINENAM
NEXT

You have cleared an external message from your Message Waiting List. The message itself still exists in your Voice Message Center until you erase it there.

Erased> 21
NEXT

You have erased an internal message.

Hold or release

If you try to access your Message Waiting List while on an active call, this display advises you to hold or release the present call.

In use: 21

You are trying to call from your Message Waiting List. The line that you are trying to use is being used by the identified Norstar user.

L01:LINENAM UMS9
NEXT CALL CLEAR

This is the Message Waiting List display. For that particular voice message, it tells you the line the call came in on, and the name of that line.

Message denied

You have tried to send a message to an invalid internal number or to a telephone that is out of service.

Message for you
MSG

You have a one item in your Message Waiting List, and you have no new entries in your Call Log. Press MSG to review the message.

Message list
SHOW ADD EXIT

The SHOW display button appears only if you have outstanding messages. Press SHOW to review or erase messages you have sent. Press ADD to send a new message.

Message to:

Enter the internal number of the telephone to which you would like to send a message.

Messages & Calls
MSG CALLS

This indicates that there is more than one item in your Message Waiting List, and there are one or more new entries in the Call Log.

Messages for you
MSG

You have more than one item in your Message Waiting List, and you have no new entries in your Call Log. Press MSG to review the messages.

No button free

You have no line button free with which to reply to a message.

No messages

You don't have any messages to cancel or there are no messages to scan through.

No number stored

There has been no number programmed for the Voice Message Center. To program the number, see the Programming chapter.

Release calls

You are trying to reply to a message while on an active call. You must release your call before entering your Message Waiting List.

Their list full

You are trying to send a message to a telephone whose message waiting list is full.

Your list full

You have tried to send a message but your telephone's list of sent messages is full. Cancel one of the messages you have sent, if possible, or wait until you have received a reply to one of those messages.

Notes

You can send up to four messages to different telephones, including your Voice Message Center. If your telephone is a Direct-Dial telephone, you can send up to 30 messages.

You can receive up to four messages from different telephones, including your Voice Message Center. The single message from your Voice Message Center may pertain to several voice messages.

Any message can be canceled either by the person who sent it or by the person who received it.

If your reply to a message is forwarded or is answered at another telephone using the Call Pickup feature, the message remains on your telephone until you cancel it or successfully contact the telephone that sent the message.

Norstar Telephones

This section covers the basic features of your Norstar telephone and optional equipment that may be attached to it.

Buttons

Feature button

Feature

You use the Feature button to invoke Norstar features. See the Using Norstar features section.

Hold button

Hold

You use the Hold button to put calls on hold. See the Hold section. It is also used in place of the OK display button on telephones with one-line displays.

Memory buttons

Memory buttons are the buttons with indicators on the M7208, M7310, and M7324 Telephones, and the dual buttons without indicators on the M7310 Telephone. There is also a single memory button, without an indicator, on the M7100 Telephone. Memory buttons can be used as any of the following buttons, except that lines and Answer buttons must appear on buttons with indicators.

Answer buttons

You can use an Answer button to monitor calls on another person's telephone. All calls to the monitored telephone appear on the Answer button. Such calls may also ring at the telephone with the Answer button, depending on how the system is configured. Answer buttons are most useful for a secretary who monitors incoming calls for one or several managers.

If more than one call is ringing at the manager's telephone, the first call appears on the secretary's Answer button. Any subsequent calls appear on Intercom buttons if they are available.

More than one secretary may have an Answer button for a single manager. This allows two or more secretaries to handle calls for a busy manager.

Similarly, one person can handle calls for up to four other people, using separate Answer buttons for each person.

A secretary's telephone should have a memory button with an indicator programmed as the Internal Autodial button for the manager's telephone. This allows the secretary to call the manager and to deal efficiently with incoming calls.

You cannot make calls using Answer buttons.

Answer buttons are set up by your Customer Service representative.

Autodial buttons

Autodial buttons let you dial numbers by pressing a single button. See the Autodial section.

Line buttons

You have one line button for each line assigned to your telephone. You press the line button to select the line you want to answer or use to make a call. Having several line buttons allows you immediate access to more than one line so you can handle and monitor calls easily. The M7100 Telephone does not have line buttons and can have a maximum of two lines. You can switch between its two lines, one active and one on hold, by pressing .



Line buttons are set up by your Customer Service representative.

Programmed Feature Buttons

Programmed feature buttons allow you to invoke Norstar features by pressing a single button. See the Feature programming section.

Release button

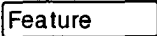

Pressing  ends a call. You do not have to put the receiver down.  also ends feature programming.

While you are on a call, do not press  to end a feature you are using (such as Show Message). If you do, you will disconnect the call. Use  instead.

Volume bar



The volume bar controls the volume of the receiver, telephone ring, Handsfree speaker, headset and background music. Press either end of the volume bar () to adjust the volume.

Headset

A headset lets you keep both hands free while you are on a call without others overhearing your telephone conversations.

If you plug a headset into your telephone while you are on a call, your telephone's microphone and speaker (or your receiver if you are on a regular call) are turned off and your headset microphone and earpiece are turned on.

You must have the Handsfree/Mute feature assigned to your telephone if you wish to use a headset.

While you are using the headset, the receiver and the switch in the telephone cradle do not work.

A headset cannot be used on an M7100 Telephone.

Using a headset

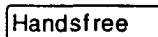
While on a call using the headset, press  to turn your headset on and off.

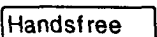
To answer a call, press .

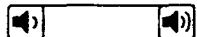
To adjust the volume, press the appropriate side of the volume bar ().

To change to a Handsfree call while you are on a call using your headset, unplug your headset. Your telephone's microphone and speaker turn on and the call becomes a Handsfree call. (It is a good idea to put the call on hold while you do this.)

You may see this prompt when you try to use a headset.

Need Handsfree

You are attempting to use a headset, but Handsfree/Mute is not programmed for your telephone. If you are not using a headset, you have accidentally plugged your telephone receiver into the headset jack on the bottom of the telephone.

Hearing aid compatibility

The receivers on all Norstar telephones are compatible with hearing aids as defined in the FCC rules, Part 68, section 68.316.

Note: Not all hearing aids are optimized for use with a telephone.

Wall mounting

Most Norstar telephones can be mounted on a wall. Contact your Customer Service representative if you wish to have any telephones in your system wall-mounted.

Page

Feature

Make a page announcement

You can make announcements over the Norstar system.

1. Press .
2. Choose a page type.
3. If necessary, choose a zone.
4. Make your announcement.
5. Press .

Page types are :

- through the telephone speakers (Internal Page)
- through an external speaker (External Page)
- both Internal and External (Combined Page)

Paging shortcuts

Instead of entering the Page feature code followed by the page type, you can enter the following shortcut codes.

Internal and zone (0 to 3)

External (code 2 has no zones)

Combined and zone (0 to 3)

Related features

Voice Call

Feature

You can make an announcement to one person by placing a voice call to their telephone.

Displays

You will see some of these displays while making a Page announcement.

Your telephone has not been programmed to allow paging.

Enter zone:
ALL

Enter the desired zone number (0-3) or press ALL to page to all zones. (0 equals all zones.)

Invalid zone

You have entered a page zone code that is not between 0 and 3.

Page choice:
SETS SPKR BOTH

Select the type of page you want by pressing:

- or SETS — Internal Page
- or SPKR — External Page
- or BOTH — Combined Page

Page timeout

The time allotted for paging has expired.

Paging ALL

The prompt appears while you are paging and shows the page zone you have chosen. Press or when you are finished paging.

Paging busy

A page is already being made in the page zone you have requested.

Notes

Page zone 0 equals all zones.

When making an announcement using External Page or Combined Page, the Long Tones feature is automatically activated for the external paging system only. This allows you to control optional equipment with the Long Tones feature.

Each Norstar telephone can be assigned access to Paging and is assigned to one of three page zones, or to none, in Administration programming.

Make sure that everyone who needs to make page announcements has a list showing who is in each page zone. See the Programming reminders section in the Programming chapter.

Priority Call

Feature 6 9

If you get a busy signal when you call someone in your office, you can interrupt them. If the Do Not Disturb feature is on at the telephone of the person that you are trying to reach and that telephone is idle, you can override Do Not Disturb. Use this feature for urgent calls only.

1. Press Feature 6 9 .
2. Wait for a connection, then speak.

A person who receives a Priority Call while on another call has eight seconds to accept or reject the call. If the person does nothing, the Priority Call feature puts the active call on Exclusive Hold and connects your call.

Displays

You will see some of these displays while making a Priority Call.

Call blocked

You tried to place a Priority Call to another Norstar telephone. The person you called has blocked your call. Try to call later.

Denied in admin

You have tried to make a Priority Call, but this feature has not been assigned to your telephone.

Make call first

You have attempted to use the Priority Call feature with no ringing or busy tone on the line. Use Priority Call only when you hear ringing or a busy signal.

Please wait

The party you are calling has eight seconds to decide whether to accept or reject your Priority Call.

Priority denied

The telephone you are calling is already in a Priority Call or is unable to receive Priority Calls.

Notes

You can make a Priority Call only while your telephone display shows one of the following prompts:

Do not disturb PRIORITY LATER

On another call PRIORITY LATER

Calling 21 PRIORITY LATER

21 busy PRIORITY LATER

If Call Forward is active at the telephone you are trying to reach, your call will be forwarded.

If the telephone receiving the Priority Call is in a conference call, the other two parties are automatically put on hold when the Priority Call is accepted.

The System Coordinator gives a telephone permission to make Priority Calls in Administration programming.

Service Modes

 Feature 8 7

Switch to a Service Mode

You can use Service Modes to make your Norstar system behave differently at different times of day. For instance, all incoming external calls can be directed to a security guard's telephone during the night, or calls to one receptionist can be directed to another receptionist during lunch.

You can activate a manual Service Mode or override an automatic Service Mode.

1. Press Feature 8 7 on a Control telephone. (See Special telephones for information on Control telephones.)
2. Select the Service Mode you want.

Cancel Service Modes

 Feature # 8 7

You can return to normal operation or cancel the manual override of an automatic mode. You cannot cancel an automatic mode.

1. Press Feature # 8 7.

Displays

You will see some of the following displays when selecting a Service Mode.

```
Night Service
QUIT  OK  NEXT
```

The name of the current Service Mode ("Night Service", in this case) is displayed. Press **NEXT** or # to see other Service Mode options. Press **OK** or Hold to select the desired mode.

```
Denied in admin
```

You are trying to activate a Service Mode from a telephone that is not a Control telephone or Direct-Dial telephone, or else all Service Modes are disabled in Administration programming.

Notes

A Service Mode allows you to change which lines ring at which telephone, to activate or deactivate the auxiliary ringer for certain lines, and to have calls to the Direct-Dial telephone ring at the Extra-Dial telephone. Service Modes can be programmed to begin automatically at certain times or they can be turned on and off at the Control telephone. Service Modes are set up in Administration programming.

Automatic Service Modes are indicated by an asterisk (*) before the name of the Service Mode on the display. You can neither manually activate nor cancel automatic Service Modes, although you can override them with manual modes.

The Control telephone can override automatic Service Modes at any time by entering the Service Modes feature code (Feature 8 7), and selecting a different Service Mode; this override will remain in effect until it is canceled by means of Feature # 8 7. Note that if you selected a Service Mode with an asterisk (*), the next automatic Service Mode will come into effect at the programmed time.

Direct-Dial calls to a Direct-Dial telephone will ring at the Extra-Dial telephone (designated in Administration programming) only when the Service Modes feature code (Feature 8 7) is entered at that Direct-Dial telephone. Note that only the Extra-Dial telephone will be activated, not the actual Service Mode (unless that Direct-Dial telephone is also a Control telephone).

Norstar provides three Service Modes named "Night", "Evening", and "Lunch". You can change these names to suit yourself. In addition, there is normal service when no Service Modes are active.

Special Telephones

You can assign several special functions to the telephones in your Norstar system. Except where noted, you do not need special hardware. A special function is assigned to a telephone either by your Customer Service representative in Configuration programming or by the System Coordinator in Administration programming.

Control telephone

The Control telephone lets you place the external lines for which it has responsibility into and out of Service Modes. See Service Modes.

Direct-Dial telephone

You can dial a Direct-Dial telephone with a single digit. The Direct-Dial telephone is usually in a central location, such as a receptionist's or secretary's desk. It is usually a Prime telephone with a CAP module.

There may be none or one Direct-Dial telephone in your system. Each telephone in the system can be assigned to the Direct-Dial telephone. There is a single Direct-Dial digit for the whole system that lets each assigned telephone call the Direct-Dial telephone.

Each Norstar Direct-Dial telephone can send up to 30 messages and each can invoke Service Modes to activate the Extra-Dial telephone. (It cannot activate the entire Service Mode unless it is also the Control telephone.)

Your Customer Service representative programs the Direct-Dial digit in Configuration programming. The Direct-Dial telephone is identified and assigned to telephones in Administration programming.

Emergency telephone

The Emergency telephone is a single-line telephone (not a Norstar telephone) that functions independently of the Norstar system. You can use the Emergency telephone when your Norstar system is not working.

Emergency Transfer/Power Failure Cut-through provides basic telephone service on external line 01 through an Emergency telephone if the power fails or if a system error occurs.

The Emergency telephone is usually located near the Key Service Unit (KSU). Each KSU can support two Emergency telephones, and each Trunk Module can support one additional Emergency telephone.

Extra-Dial telephone

In Service Modes, a second telephone can be assigned to ring on calls made to the Direct-Dial telephone. There may be one Extra-Dial telephone for the Direct-Dial telephone, and it may be a different telephone in each Service Mode.

Hotline telephone

You can call a programmed internal or external telephone number simply by picking up the receiver of the Hotline telephone (or by pressing).

A Hotline telephone can be set up to dial an operator or an emergency number. You should put a notice by the Hotline telephone to let people know which number will be dialed when they lift the receiver.

If the Hotline telephone is set up to dial an external number using the Prime line, there must be an external Prime line assigned to the telephone. If not, the Hotline call will fail.

The System Coordinator sets up the Hotline telephone, the telephone number it dials, and the line on which that number is dialed, in Administration programming.

To bypass a Hotline

Press a line button, or use the Pre-Dial or Automatic Dial feature before you pick up the receiver or press .

The following displays may occur at a Hotline telephone.

The line assigned to the Hotline is in use. Make the call using normal methods or wait until the Hotline line is free.

The Hotline has been set up to dial an external number on a Prime line but the Hotline telephone does not have a Prime line. This must be corrected in Configuration or Administration programming.

The Hotline has been set up to dial an external number on a Prime line but the Hotline telephone has an internal Prime line and no access to line pools. This must be corrected in Configuration or Administration programming. This message may also appear if the line pool assigned to the telephone is busy.

Prime telephone

Each line in a Norstar system can have a telephone assigned to it as a Prime telephone. Calls not answered at their normal destinations are transferred to the Prime telephone. The Prime telephone is usually the telephone on the receptionist's desk and it is often the Control telephone. The Prime telephone often has a Central Answering Position module attached to it as well. A Prime telephone is assigned to a line in Configuration programming.

See the Answering the telephone section for the displays that may occur at a Prime telephone.

Speed Dial

Feature 0

Make a Speed Dial call

You can quickly dial external telephone numbers that have been programmed onto Speed Dial codes.

1. Press .
2. Enter the appropriate two-digit Speed Dial code.

Norstar supports two types of Speed Dial codes, Personal and System. System Speed Dial codes are from 01 to 70. The System Coordinator can assign numbers to System Speed Dial codes for the entire system in Administration programming. Personal Speed Dial codes are from 71 to 94 and may have different numbers assigned to them on each telephone. Users can program their own Personal Speed Dial numbers.

Program Personal Speed Dial

Feature * 4

You can add or change a Personal Speed Dial number on your telephone.

1. Press .
2. Enter the code that you want to associate with a telephone number.
3. If you want to include a line selection for this number, select the line or line pool button. For the M7100 Telephone, you can select a line pool button only.
4. Enter the number you want to program.
5. Press **OK** or .

Displays

You will see some of these prompts while using or programming Speed Dial.

9_
QUIT BKSP OK

Continue entering the number you wish to program. You can change the number by pressing the left side of the volume bar or by pressing **BKSP**. When you are finished, press or **OK**.

Access denied

You have tried to program a Personal Speed Dial number while someone else on the system is in Configuration or Administration programming.

Autodial full

You have tried to enter a new Personal Speed Dial Number, but the memory for these numbers in your Norstar system is full.

Enter code:

Enter a two-digit code between 71 and 94 for the Personal Speed Dial number you want to program.

Enter digits
QUIT OK

Enter the telephone number you wish to program exactly as you would if you were dialing it normally. When you are finished, press or **OK**.

Invalid code

You have entered a code outside the code range (01-94).

Line in use

The line associated with the Speed Dial number you are trying to use is busy.

No number stored

There is no number stored on the Speed Dial code you have dialed.

Program and HOLD

This display pertains only to the M7208 Telephone. If you want to program a line or line pool selection for this Speed Dial, select the line or line pool button. Otherwise, enter the telephone number you wish to program exactly as you would if you were dialing it normally. When you are finished, press .

Program and OK
QUIT OK

If you want to program a line or line pool selection for this Speed Dial, select the line or line pool button. Otherwise, enter the telephone number you wish to program exactly as you would if you were dialing it normally. When you are finished, press or OK.

Select a line

There is no line associated with the Speed Dial number you are trying to use. Select a free external line or line pool and enter the Speed Dial feature code again.

Speed dial >

Enter a two-digit Speed Dial code (01-94). You must enter the zero for codes 01 to 09.

Notes

There is no difference between using Personal Speed Dial and using System Speed Dial. They differ only in how you program them.

Speed Dial numbers may include line choices and Host System Signaling codes.

Speed Dial numbers are subject to the same Class of Service as regularly dialed numbers. System Speed Dial numbers can be programmed to bypass dialing restrictions.

Normally, Speed Dial numbers are shown on the display while they are being dialed. System Speed Dial numbers may be programmed to show a Speed Dial name instead of the number, keeping the actual number confidential.

System features

The following system features are available for the entire Norstar system, **with the exception of Disconnect Supervision**. The availability of Disconnect Supervision is dependent on the presence of an Open Switch Interval (OSI) message.

Accidental Disconnect Protection

If you accidentally drop the receiver back into the telephone cradle while answering a call, you can quickly retrieve the call.

1. Pick up the receiver again or press . You are connected to your call.

Automatic telephone relocation

If Automatic telephone relocation is enabled, you can move your telephone from one Norstar jack to another without it losing any of its custom programming. Your Customer Service representative enables Automatic telephone relocation in Configuration programming.

Background Music

You can listen to music through your telephone speaker.

1. Press .

WARNING

In accordance with U.S. copyright law, a license may be required from the American Society of Composers, Authors and Publishers or a similar organization if radio or TV broadcasts are transmitted through the Background Music feature of this telecommunication system.

Northern Telecom Inc. hereby disclaims any liability arising out of the failure to obtain such a license.

The music stops automatically if you make or answer a call.

Your Customer Service representative makes this feature available to all telephones in Configuration programming. You will need to supply a music source, such as a radio, attached to your KSU.

Cancel Background Music

Feature # 8 6

You can cancel Background Music.

1. Press Feature # 8 6 .

Class of Service

The Class of Service for a call consists of all the Norstar features and lines available to you for that call. This is determined by the features assigned to the telephone in Administration programming, including all Dialing Filters.

Users who need to dial numbers not permitted by the Class of Service of the line or telephone that they are using, can switch to a different Class of Service by entering a Class of Service Password.

Internal numbers

Each telephone in the Norstar system has its own internal number. The length of internal numbers in your system is 2 digits. Your Customer Service representative assigns internal numbers in Configuration programming.

To find out your internal number, use the Button Inquiry feature (Feature * 0) on an internal line button. On the M7100 Telephone, Button Inquiry shows your internal number followed by the function assigned to your single memory button.

Lines

The following features and characteristics are associated with the use of lines.

Disconnect Supervision

Disconnect Supervision is available when an Open Switch Interval (OSI) message is provided on a line by the public telephone system.

If Disconnect Supervision is available, your Customer Service representative assigns Disconnect Supervision to lines in Configuration programming. When Disconnect Supervision is assigned to a line, the Norstar system monitors the length of the OSI on that line to determine when an external caller hangs up. This allows the system to release the line for other uses.

You can determine if a line is disconnect supervised by referring to the *Compact DR5 Programming Record*.

Line appearance

Any of the lines in your system may appear at any of your telephones. Your Customer Service representative assigns lines to telephones in Configuration programming.

Usually, only the lines that are appropriate for a particular person appear at that person's telephone. When a line is assigned to a telephone it is automatically given a line button on that telephone, if a button is available. The M7100 Telephone has no line buttons for its lines.

Normally, you cannot answer a call that is ringing on a line that does not appear on your telephone. To pick up such a call, use Call Pickup, Call Park, or Transfer.

Hung lines

A line that has been redirected using Line Redirection may remain busy after a call is over. If this happens, the outgoing line for the redirection will also remain busy. These are hung lines and you must clear them.

A line indicator that has been solid for a long time is the only real indication that a line is hung. However, the solid line indicator may also indicate a genuine call in progress. Make reasonably sure that the line is indeed hung before clearing it or you may cut off a real conversation.

You can clear a hung line only at the telephone that was used to redirect the line.

1. Press * 0 at the telephone that was used to redirect the line.
2. Press the button of the redirected line.
3. Press SHOW or #.
4. Press DROP or *. The hung line is cleared.

Clearing the redirected line clears the outgoing line for the redirection as well.

Line Pools

A line pool allows each telephone access to external lines from a group (or "pool") of external lines. You can access such lines by pressing an Intercom button and entering a line pool access code, by entering the feature code and entering a line pool access code, or by pressing a memory button programmed with the line pool feature code and a line pool access code.

Your Customer Service representative gives telephones access to Line Pools and assigns line pool access codes in Configuration programming.

Private lines

A Private line is exclusive to a particular telephone. Calls that are put on hold or left unanswered on a Private line cannot be picked up at any telephone except the Prime telephone.

Your Customer Service representative assigns private lines in Configuration programming.

Prime line

Your telephone can be programmed to select an internal or external line or a line pool automatically whenever you lift the receiver or press . This is your Prime line.

Your Customer Service representative assigns your prime line in Configuration programming.

Ringling Line Preference

Each telephone in the Norstar system can be programmed by your Customer Service representative to ring or remain silent for incoming calls on any external lines that appear on the telephone.

For example, a telephone may have buttons assigned for lines 01 to 03, but have only lines 01 and 02 programmed to ring. An incoming call on any of the three lines causes a line button indicator to flash, and the telephone can be used to answer the call. This is especially useful for people who monitor other telephone lines, but want only their own lines to actually ring.

If a telephone has an external line as a Prime line, that line is usually made to ring.

System Speed Dial

Speed Dial codes 01 to 70 are the same for the entire system. See the Speed Dial section for details.

Time features

The Time features let you check the present time and how long you have spent on a call.

Call Duration Timer

Feature

You can see how long you spent on your last call or how long you have been on your present call.

1. Press .
2. Read the display.

Show Time

Feature

You can see the present date and time while you are on a call.

1. Press .
2. Read the display.

Displays

One of the following displays will occur when you use a Time feature.

Make call first

You have not made a call since your telephone's clock was last reset.

21 02:47

The display shows the last call you made, or the current call, and the total elapsed time in minutes and seconds.

Apr 9 9:54 am

The display shows the present time.

Transfer

Feature 7 0

Transfer a call

You can transfer a call to a telephone in your Norstar system or external to Norstar.

1. Make a call, answer a call or take a call off hold.
2. Press or **TRANSFER** (or if programmed).
3. To transfer within the Norstar system: dial an internal telephone number or press an Internal Autodial button.
OR
To transfer external to Norstar: press a line button and dial the number of the person to whom you want to transfer the call, or press an External Autodial button.
4. Announce the call after the called party answers and complete the transfer as follows.
OR
If you do not want to announce the call, complete the transfer as follows.
5. Press or **JOIN**, or a programmed Call Queuing button if you wish to answer another call.
6. The call is immediately transferred.

Note: When transferring an external call to an external number, note the following restrictions: at least one of the external calls must have been an incoming call, and that call must be on a disconnect supervised line.

Unsupervised Conference

You can create an Unsupervised Conference by dropping out of a conference you established, leaving the other two to talk to each other. If both parties are external, certain restrictions apply. See Notes at the end of this section.

1. Establish a Conference call as described in Conference.
2. Press or **TRANSFER** (or if programmed).

If you are unable to establish an unsupervised conference, you can put the conference on hold. See the Conference section.

Transfer using Hold

Transfer using Hold can only be used to transfer an external call to another internal telephone that has a button for the line that the external call is on.

Call the person you want to transfer the call to and tell them there is a call on hold for them. **Do not enter the Transfer feature code.** To accept the call, your co-worker presses the line button with the flashing indicator.

An M7100 Telephone can transfer a call using Hold but it cannot receive a call transferred in this way.

Displays

You will see some of the following displays while transferring calls.

21 busy CANCL RETRY

The telephone of the person to whom you tried to transfer a call already has the maximum number of calls that it can handle. Press **RETRY** to enter a new internal number. On the M7100 telephone, you will automatically be returned to the **Transfer to:** prompt.

21 DND
CALLBACK

The person to whom you transferred an external call has Do Not Disturb active on their telephone. Press CALLBACK or the flashing line button to reconnect to the call. On the M7100 Telephone, lift the receiver.

21 hung up

The internal caller you were trying to transfer hung up before the transfer was complete.

23 hung up
CANCL RETRY

The internal user to whom you were trying to transfer the call hung up before the transfer was complete.

21 no reply
CALLBACK

The person to whom you transferred an external call did not answer. Press CALLBACK or the flashing line button to reconnect to the call. On the M7100 Telephone, lift the receiver.

21>22
CANCL RETRY JOIN

Press RETRY if, after talking to the person at internal number 21, you decide to transfer the call to someone else. Press Rls or JOIN to transfer the call from internal number 21 to 22.

Call transferred

Transient message to indicate that the transfer was successfully completed.

Do not disturb
CANCL RETRY JOIN

The person to whom you tried to transfer an internal call has Do Not Disturb active on their telephone. Press CANCL or the flashing line button to reconnect to the call. On the M7100 Telephone, enter the transfer cancellation code (Feature # 7 0) to reconnect to the call.

Invalid number
CANCL RETRY

An invalid DN has been entered, or the transfer feature has been invoked before the complete DN has been entered.

Line 01 hung up

The external caller you were trying to transfer has hung up before the transfer was complete.

Line 01>21
CANCL RETRY JOIN

Press JOIN to transfer the call on line 01 to telephone 21. Press RETRY if, after talking to the person at internal number 21, you decide to transfer the call to someone else.

Make call first

You have tried to use the Transfer feature when you have no call to transfer.

Not in service
CANCL RETRY

The telephone to which you are trying to transfer a call is out of service.

On another call
CANCL RETRY JOIN

The person to whom you tried to transfer a call is on another call. Press RETRY to enter a new internal number. Press or JOIN to complete the transfer.

Restricted call
CANCL RETRY

You cannot transfer the call because of telephone or line restrictions.

Still in transfer
CANCL RETRY

Once you have invoked the Transfer feature you must complete the transfer actions before you can access a new feature, answer another alerting call or select an outgoing line.

Transfer denied
CANCL RETRY

Your transfer cannot be completed for one of these reasons:

- All the internal resources needed to perform a transfer are in use. Try again later.
- You have tried to transfer an external call to another external party. Some restrictions apply. See Notes at the end of this section.
- An Unsupervised Conference is not possible for your call. See Notes at the end of this section.

Transfer to:
CANCL

Dial the internal telephone number of the person to whom you want to transfer the call. If you are already connected to that person, press the line button of their call.

Notes

If an external call is transferred to a busy telephone, or not answered after a few rings, the call automatically rings you back and the display indicates that the telephone was busy or that no one answered. Callback doesn't apply when an external call is transferred to an external number.

You can establish an Unsupervised Conference whether the other two people are inside or outside the Norstar system. However, if both of the other people are outside the system there are some restrictions: at least one of the outside callers must have called you and that call must be on a disconnect supervised line.

When transferring an external call to an external number, note the following restrictions: at least one of the external calls must have been an incoming call, and that call must be on a disconnect supervised line.

In certain situations, you may experience lower volume levels when using external Transfer and Unsupervised Conference with two external calls.

Voice Call

Feature

Make a voice call

You can make an announcement or begin a conversation through the speaker of another telephone in the system.

1. Press .

Mute Voice Call tones

When a Voice Call begins at your telephone, you hear a beep every 15 seconds as a reminder that the microphone is on. You can stop it beeping.

1. Pick up the receiver or press .

Handsfree Answerback

If Handsfree Answerback is assigned to your telephone, you can respond to a Voice Call without touching the telephone.

1. When someone makes a Voice Call to you, simply start talking. Your telephone's microphone picks up your voice.

Your telephone will beep periodically to remind you the microphone is on. You can stop it beeping.

1. Pick up the receiver or press .

Voice Call Deny

Feature

You can prevent your telephone from receiving Voice Calls.

1. Press . Voice Calls will ring like regular internal calls. Your other calls will proceed normally.

Cancel Voice Call Deny

Feature

You can cancel Voice Call Deny.

1. Press .

Displays

You will see some of these displays while making a Voice Call.

Dial voice call

Dial the internal number or press the internal Autodial button of the person to whom you want to speak.

No voice call

The telephone receiving the call cannot accept Voice Calls for one of the following reasons: it is active or ringing with another call; it is in Call Forward mode; it is in Do Not Disturb mode; it has Voice Call Deny turned on; it is not a Norstar telephone.

Your call proceeds automatically as a regular ringing call.

Voice call

The line is open for you to speak.

Notes

Once you have answered a Voice Call, you can put it on hold, transfer it, or otherwise treat it as a normal call.

When you have Handsfree Answerback assigned to your telephone, and you are using an on-hook Dialing Mode, the microphone and speaker are both activated for external calls.

The System Coordinator assigns Handsfree Answerback to a telephone in Administration programming. You can not assign Handsfree Answerback capability to the M7100 Telephone.

If you do not have Handsfree Answerback assigned to your telephone, you can answer a Voice Call by picking up the receiver.

User cards

This chapter includes reproductions of the *Compact DR5 Telephone Feature Card*, the *Compact DR5 Prime Telephone User Card* and the Norstar Telephone User Cards. To best assist your co-workers, you should familiarize yourself with general Norstar feature operation and with the specific operation of each Norstar telephone model.

telemanuals.com

4-2 / Compact DR5 Telephone Feature Card

Using Norstar features

Using a Norstar* feature

1. Press , and enter the desired feature code on the dial pad.
OR
Press the programmed memory button.
2. Follow the display messages.

Note: On M7310 and M7324 Telephones, some features are also available on the display buttons.

Programming a Norstar feature on a memory button

1. From an idle telephone, or with your calls on hold, press * .
2. Press the memory button that you want to program. (This step is not required on the M7100 Telephone.) See your telephone user card for the location of the memory buttons.
3. Enter the feature code you want to program.

Personalizing your telephone

Autobumping

Allows the oldest log entry to be deleted from a full Call Log when a new item is logged, so that the new log entry can be stored. For more information, see Call Log.

Cancel #

Background Music

Allows you to listen to music (provided by your office) through your telephone speaker when you are not on a call.

Cancel #

Button Inquiry

*

Checks what is programmed on any button. Use this feature when labeling memory buttons.

Call Log Password

*

Programs a password for your Call Log. If you forget your password, see your System Coordinator.

Class of Service Password

Overrides the Class of Service on a telephone to allow you to make a call from that telephone. The Class of Service determines which numbers you can dial. Switch from one Class of Service to another using this feature code and a password provided by your System Coordinator.

Contrast Adjustment

*

Adjusts the contrast of your telephone display. Press through (depending on your telephone).

Dialing Modes

*

Changes the on-hook Dialing Modes. The three Dialing Modes are:

Automatic Dial: If you have a Prime line, dial a telephone number without pressing a line button. A line is selected automatically.

Pre-Dial: Dial a telephone number. Edit it by pressing **BKSP**, or the left side of . Press a line button or a line pool button to place the call.

Standard Dial: Select a line, then dial a telephone number.

Do Not Disturb

Prevents incoming calls from ringing at your telephone.

Cancel #

* Meridian and Norstar are trademarks of Northern Telecom.

Compact DR5 Telephone Feature Card / 4-3

Language Choice	Feature <input type="text"/> * 5 0 1	Selects the English language for the telephone display.
	Feature <input type="text"/> * 5 0 2	Selects the alternate language for the telephone display.
Moving Line Buttons	Feature <input type="text"/> * 8 1	Changes the position of a line button. Remember to switch the button caps after the line button is moved. Lines cannot be moved to positions occupied by <input type="text"/> Intercom <input type="text"/> , <input type="text"/> Handsfree <input type="text"/> , Or <input type="text"/> Answer <input type="text"/> buttons. This feature is not available on the M7100 Telephone.
Programming Call Log	Feature <input type="text"/> * 8 4	Select the type of calls that will be automatically stored in your Call Log.
Programming memory buttons	Feature <input type="text"/> * 1	External Autodial: Stores a line (optional) or a line pool (optional) and an external telephone number onto a memory button for one-button access to that number.
	Feature <input type="text"/> * 2	Internal Autodial: Stores an internal telephone number onto a memory button for one-button access to that telephone number.
	Feature <input type="text"/> * 3	Program Features: Stores a feature onto a memory button for one-button access to that feature.
Note: <input type="text"/> Line <input type="text"/> , <input type="text"/> Intercom <input type="text"/> , <input type="text"/> Answer <input type="text"/> , Or <input type="text"/> Handsfree <input type="text"/> cannot be programmed.		
Programming a feature button:		
<ol style="list-style-type: none">1. Press <input type="text"/> Feature <input type="text"/> * 3 <input type="text"/>. (For M7100 Telephones, go to step 3.)2. Press the memory button you want to program.3. Enter the feature code of the feature you want to program.4. If you entered the Line Pool feature code in step 3, enter the access code for a line pool immediately following the feature code.		
Ring Type	Feature <input type="text"/> * 6	Selects a distinctive ring to help differentiate between your telephone and others nearby. Enter the feature code and press NEXT or <input type="text"/> 1 <input type="text"/> through <input type="text"/> 4 <input type="text"/> to select the new Ring Type. Press <input type="text"/> Hold <input type="text"/> or OK to store the new ring.
Ring Volume	Feature <input type="text"/> * 8 0	Makes your telephone ring so you can adjust the volume, even while you are on a call.
Run/Stop	Feature <input type="text"/> * 9	When using the External Autodial programming feature, inserts a break point between two or more numbers stored on a memory button. Press the memory button once to dial the first number; a second time to dial the second number, and so on.

4-4 / Compact DR5 Telephone Feature Card

Speed Dial

Feature * 4

Personal: Programs a telephone number into a Personal Speed Dial code (from 71 to 94).

Programming a Personal Speed Dial code:

1. Press Feature * 4 to enter Personal Speed Dial codes.
2. Enter a two-digit code (from 71 to 94).
3. To program a line as part of the Speed Dial code, press a line button or a line pool button.
4. Enter the telephone number to be assigned to that code. Telephone numbers cannot exceed 24 digits.
5. Press Hold or **OK** to finish programming.

Voice Call Deny

Feature 8 8

Prevents your telephone from receiving Voice Calls, permits only ordinary ringing calls.

Cancel Feature # 8 8

Remote system signaling

Link

Feature 7 1

Generates a Link signal (also called flash or recall) on an active line to access other systems or carriers.

Long Tones

Feature 8 0 8

Permits communication with devices (such as fax or answering machines) on an active line that use longer tone signals. The tone lasts as long as a dial pad button is held down, and only for the current call.

Pause

Feature 7 8

When programmed in an External Autodial sequence, inserts a 1.5-second delay in a number being dialed.

*

For Pulse and Tone Dialing

For Pulse Dialing only

Programmed Release

Feature * 8 9

When programmed at the end of an External Autodial sequence, performs the same function as **Rls**.

System features

Call Duration Timer Feature Briefly displays the length of your current call. If your telephone is idle, the length of your most recent call is displayed.

Call Log Feature Opens your Call Log to view stored caller information. The Call Log displays use special characters.

- 1 A new item in the Call Log is underlined.
- Ⓜ Answered calls are identified.
- Ⓢ Long distance calls are identified.
- ✓ The displayed information has been truncated.

Note: Call Log is only available if you have subscribed to Call Display services from your local telephone company.

Calling from your Call Log:

1. Navigate to the appropriate log item, and display the number.
2. Edit the number, if required. The leading digits may need to be trimmed, or digits may need to be added for Long Distance or line pool access. See your System Coordinator if you require assistance when editing a call log number.
3. Press a line button or a line pool button.
4. Lift the receiver.

Message Feature **Reply to Message:** Review your list of external and internal display messages, and return calls.

Cancel Feature #

Feature

Send Message: Leave a message on a co-worker's telephone display to call you back.

Cancel Feature #

Page Feature

Allows you to make announcements through either the internal or external speakers, or both. Enter the feature code, the page code (1 for internal, 2 for external, or 3 for both), and the zone (0 to 3).

Feature

External: Allows you to make announcements through your office's loudspeaker system (if connected).

Feature

External/Internal: Allows you to make announcements through both your Norstar telephone speakers and your office's loudspeaker system. Enter the feature code, and the zone (0 to 3).

Feature

Internal (Zone): Allows you to make announcements, through the Norstar telephone speakers, to a group of Norstar telephones. Enter the feature code, and the zone (0 to 3). 0 pages all zones.

Service Modes Feature

Activates one of up to three different telephone answering options, eliminating the need to forward all your calls. Only an assigned Control Telephone can turn on Service Modes. See your System Coordinator.

Cancel Feature #

Show Time Feature

Briefly displays the date and the time while you are on a call.

4-6 / Compact DR5 Telephone Feature Card

Handling calls

Call Forward	Feature <input type="text" value="4"/> <input type="text" value="4"/> Feature <input type="text" value="8"/> <input type="text" value="2"/>	Sends your calls to another telephone in your Norstar system. Cancel Feature <input type="text" value="4"/> # <input type="text" value="4"/> Camp-On: Re-routes a call to another telephone even if all its lines are busy.
Call Information	Feature <input type="text" value="8"/> <input type="text" value="1"/> <input type="text" value="1"/>	Briefly displays the name, number and line name of a ringing or held call. Press <input type="text" value="4"/> or VIEW repeatedly to cycle through the three displays of information.
Note: Names and numbers for external callers are displayed only if you have subscribed to Call Display services from your local telephone company.		
Call Park	Feature <input type="text" value="7"/> <input type="text" value="4"/> Intercom <input type="text" value="X"/> <input type="text" value="0"/> <input type="text" value="1"/> or <input type="text" value="X"/> <input type="text" value="0"/> <input type="text" value="2"/>	Automatically puts a call on hold so that it can be retrieved from any telephone in your Norstar system. The display shows a retrieval code, X01 or X02. The retrieval code is made up of a programmable Call Park prefix (0 to 9), followed by a call number (01 or 02). Call Park Retrieval: Answers a parked call from any telephone in your Norstar system by pressing <input type="text" value="Intercom"/> and entering the retrieval code. On the M7100 Telephone, enter just the retrieval code.
Conference	Feature <input type="text" value="3"/>	<p>Setting up a three person call:</p> <ol style="list-style-type: none">1. Make or answer the first call.2. Put the first call on hold.3. Make or answer the second call.4. Press <input type="text" value="Feature"/> <input type="text" value="3"/> (or press <input type="text" value="Conf/Trans"/> if programmed).5. Press the line button of the first held call. (This step is not required on the M7100 Telephone.)6. Press <input type="text" value="Ris"/> to end the conference. <p>Splitting a conference: To speak privately to one of the callers, or to drop one call and stay connected to another, or to hold both parties as separate calls, you must first split the conference.</p> <ol style="list-style-type: none">1. Press the line button for one of the calls. The other call is put on hold. To re-establish the conference, press <input type="text" value="Feature"/> <input type="text" value="3"/>. <p>Removing yourself from the conference temporarily:</p> <ol style="list-style-type: none">1. Press <input type="text" value="Hold"/>; the other two callers can still speak to each other. <p>Removing yourself from the conference permanently (Unsupervised Conference †):</p> <ol style="list-style-type: none">1. Press <input type="text" value="Feature"/> <input type="text" value="7"/> <input type="text" value="0"/> (or <input type="text" value="Transfer"/> if programmed). The other two parties remain connected.
Do Not Disturb	Feature <input type="text" value="8"/> <input type="text" value="5"/>	Blocks alerting calls at your telephone. Also blocks a Priority Call when all lines on your telephone are in use.

Exclusive Hold	Feature <input type="text" value="7"/> <input type="text" value="9"/> or <input type="text" value="Feature"/> <input type="text" value="Hold"/>	Temporarily suspends an external call and prevents other telephones from picking it up. Exclusive Hold Retrieval: Press <input type="text" value="Line"/> of the held call. (Press <input type="text" value="Hold"/> on the M7100 Telephone.)
-----------------------	---	---

† Some external lines may not support this feature. See your System Coordinator for more information.

Compact DR5 Telephone Feature Card / 4-7

Group Listening	Feature <input type="text" value="8"/> <input type="text" value="0"/> <input type="text" value="2"/>	Allows you to use both the receiver and your speaker at the same time while you are on a call. Use the Mute feature on the <input type="text" value="Handsfree"/> button to disable the telephone microphone. If you experience feedback, turn the volume down, and before hanging up, press <input type="text" value="Ris"/> . Cancel Feature <input type="text" value=""/> # <input type="text" value="8"/> <input type="text" value="0"/> <input type="text" value="2"/>
Line Redirection†	Feature <input type="text" value="8"/> <input type="text" value="4"/>	Redirects one or more lines on your telephone so that calls coming in on the line(s) are directed to one or more locations outside the Norstar system. This feature is not available on the M7100 Telephone. Cancel Feature <input type="text" value=""/> # <input type="text" value="8"/> <input type="text" value="4"/>
Logit	Feature <input type="text" value="8"/> <input type="text" value="1"/> <input type="text" value="3"/>	Store caller information for the current active call in your Call Log. Note: Names and numbers for external callers are displayed only if you have subscribed to Call Display services from your local telephone company.
Privacy	Feature <input type="text" value="8"/> <input type="text" value="3"/>	When Privacy is on, other Norstar users with the same line are prevented from joining your current external call. If Privacy is off, other Norstar users with the same line can join in on your external call by pressing that line button. Enter the feature code a second time to restore the original setting.
Transfer	Feature <input type="text" value="7"/> <input type="text" value="0"/>	Sends a call to another telephone in your Norstar system or external to Norstar.

Using Transfer †

1. Make a call, answer a call or take a call off hold.
2. Press Feature (or if programmed).
3. To transfer within the Norstar system: dial an internal telephone number or press an Internal Autodial button.

OR

To transfer external to Norstar: press a line button and dial the number of the person to whom you want to transfer the call, or press an External Autodial button.

4. Announce the call after the called party answers and complete the transfer as follows.

OR

If you do not want to announce the call, complete the transfer as follows.

5. Press or **JOIN**, or a programmed Call Queuing button if you wish to answer another call.
6. The call is immediately transferred.

External Transfer using Unsupervised Conference †

You can also do an external transfer using Unsupervised Conference:

1. Establish a Conference call as described in Conference.
2. Press Feature (or if programmed). The other two parties remain connected.

Note: If an external call is transferred to a busy internal line, or not answered after a few rings, the call automatically rings you back and the display indicates that the line was busy or that no one answered.

† Some external lines may not support this feature. See your System Coordinator for more information.

Answering and making calls

Call Pickup

Feature

Feature

Feature

Directed Pickup: Answers a selected telephone in your system.

Group Pickup: Answers a call that is ringing at another telephone in the same pickup group. The external call that has been ringing longest is answered first.

Trunk Answer: Answers an external call that is ringing on a line that has been placed into Service Modes from any telephone in the Norstar system. This feature does not work on private lines.

Call Queuing

Feature

Answers a call when several calls arrive at the same time. The external call that has been ringing longest is answered first.

Last Number Redial

Feature

Automatically redials the last external telephone number that you dialed. This feature is available on the memory button on most telephones.

Line Pools

Feature

Telephones can share several external lines for making outgoing calls without requiring each telephone to have a button for every line.

Using a Line Pool:

1. Press and enter the access code for one of the Line Pools assigned to your telephone.

OR

If you have no free internal line, enter the feature code and then a Line Pool access code or press (if programmed).

2. If you are using a line pool which connects you to the public network, dial the telephone number of the person you want to call.

OR

If you are using a line pool which automatically connects you to a system other than Norstar, follow the procedure for using that system. Ask your System Coordinator if you need help.

Note: See your System Coordinator for your Line Pool access code.

Priority Call

Feature

Interrupts a call at another telephone, or overrides Do Not Disturb at a telephone. See your System Coordinator.

Ring Again

Feature

When another telephone or Line Pool within the Norstar system is busy, Ring Again signals you to call back when the telephone or Line Pool becomes available.

Cancel

Saved Number Redial

Feature

When you are active on a call, this feature stores the external telephone number of a call you have dialed. When you are not active on a call, this feature redials the number previously stored.

Speed Dial

Feature

Dials the number stored for a Speed Dial code. After entering the feature code, enter the two-digit System Speed Dial code (01 to 70) or the two-digit Personal Speed Dial code (71 to 94) for the number you want. For an explanation of the differences between System Speed Dial and Personal Speed Dial see your System Coordinator.

Voice Call

Feature

Begin a conversation through the speaker of another telephone without first making the other telephone ring. To answer a Voice Call, speak, pick up the receiver, or press .

The Norstar Prime Telephone

What is a Prime Telephone?

A Prime Telephone can be any Meridian Norstar* telephone that has been assigned to provide a backup answering service for incoming external calls. An external call rings at a Prime Telephone when the call is not answered at any other Norstar telephones with that call's line appearance.

A Prime Telephone can be any one of the following:

- any Norstar telephone
- an M7310 telephone with a Busy Lamp Field (BLF)
- an M7324 telephone with Central Answering Position (CAP) modules.

Your role in operating a Prime Telephone

As the assigned Prime Telephone operator, you are responsible for answering unanswered external calls. You are alerted to these calls when your telephone display shows you a descriptive message, the line indicator ► flashes, and the call rings.

After answering a call, you may take a message or send the call to another telephone.

Who assigns the external lines for my Prime Telephone?

Check with your System Coordinator to determine which external lines have been assigned to ring at your Prime Telephone when unanswered at another Norstar telephone. To help you do your job well, your System Coordinator should provide a list of names and numbers associated with each internal telephone and external line, and a list of System Speed Dial names and numbers. Your System Coordinator can also tell you which features have been assigned to your telephone.

* Meridian and Norstar are trademarks of Northern Telecom.

Answering calls

When do I answer a call?

You answer a call if:

- someone within the system calls you. You hear the Norstar internal ring (two quick rings followed by a longer pause), and an indicator ► flashes beside one of your telephone's Intercom buttons.
- an external call comes directly to your Prime Telephone. You hear the external ring, and an indicator ► flashes beside one of your telephone's external line buttons.
- a call is routed to your Prime Telephone from somewhere else within the system. You hear an internal ring, an external ring, or the Camp-On tone (two quick beeps), and you see a message on the display of your telephone.

Note: You do not answer the call if your Prime Telephone does not ring.

How do I answer a call?

If you want a line to be automatically selected:

1. Pick up the receiver or press (if assigned).

OR

If you have Automatic Handsfree capability, you can manually select a line:

1. Press the line button with a slow flashing indicator ►.

Note: A fast flashing indicator ► shows that a line is on hold.

Dealing with more than one call at once

The Call Queuing feature allows you to answer incoming calls by automatically selecting the next call with the highest priority for you.

Use Call Queuing to select a waiting call when you have more than one incoming call at your telephone or when you are already on a call.

When a waiting call alerts you by ringing at your telephone, or by sending Call Queuing tones:

1. Press or the Call Queuing button if programmed.
The call you were on is automatically put on hold and the new call is answered.
2. To return to a previous call:
Press the line button of the call on hold.
3. Continue to use Call Queuing until all incoming calls are answered.

Handling calls

Handling calls using display messages

The display messages which appear when calls are automatically routed to your Prime Telephone should help you to understand why you received those calls. This information is useful when you need to decide what to do with the call once you answer it.

The following table lists some display messages that could appear on a Prime Telephone when calls are routed to you:

Prime Telephone display message	What is happening
DND from 23	The person at telephone 23 has routed an external call to you using Do Not Disturb while the call was ringing.
DND transfer	The system has routed an external call to you from a telephone placed in Do Not Disturb mode to prevent calls from ringing.
DRT Line 02	Nobody answered this call on line 02, so the system has routed it to you.
Held by KAREN	Karen has held a call for too long, so the system has routed it to you.
Line 01 to prime	There is no telephone that can receive a call on line 01, so the system has routed it to you.
Line 04 callback	A transferred, camped, or parked call on line 04 was returned to the originator using the Callback feature, but was not answered.

The Held Line Reminder message **On hold: LINENAM** is repeated periodically after the first message **Held by KAREN** appears. This message is accompanied by the same tone used with the Camp-On feature (two quick beeps).

The Held Line Reminder message only shows the line name of one held call. If there is more than one call on hold, the line name of the oldest held call is shown. When you retrieve the oldest held call and end that call by hanging up or putting it on hold, the display will change to show the next oldest held call, if any.

Note: if Your KSU has an earlier system version, the Held Line Reminder message will be **Held call**.

Completing a call

Your options

You have just answered a call for someone else. What do you do next?

You can:

- Transfer the call to another telephone within or outside of the Norstar system.
- Camp the Call on another Norstar telephone.
- Announce the call to the office, asking that someone take the call.
- Take a message.

Transferring the active call

Before transferring a call, check whether the telephone to which you want to transfer is already busy:

- Is there an indicator ► beside the Internal Autodial button for the other telephone?
- If you have a BLF, is the indicator on for the other telephone?

Do not use transfer to complete a call if the other Norstar telephone is busy.

To transfer a call:

1. Make a call, answer a call or take a call off hold.
2. Press (or if programmed).
3. To transfer within the Norstar system: dial an internal telephone number or press an Internal Autodial button.

OR

To transfer external to Norstar: press a line button and dial the number of the person to whom you want to transfer the call, or press an External Autodial button.

4. If you wish, announce the call after the called party answers.
5. Press or **JOIN**, or a programmed Call Queuing button if you wish to answer another call.
6. The call is immediately transferred.

Transfer using Unsupervised Conference:

You can also do an external transfer using Unsupervised Conference:

1. Make sure you have two calls, one active and one on hold.
2. Press .
3. Take the call off hold to establish a Conference.
4. Press (or if programmed). The other two parties remain connected.

Note: Some external lines may not support an unsupervised conference call. In this case, you may put the conference on hold, allowing the other two parties to continue talking to each other.

Note: Do not use the button to create an unsupervised conference. Although it will create an unsupervised conference with internal parties, it will not work in a conference with two external parties.

Completing a call

Camping the call

If the Norstar telephone you want to transfer the call to is busy on another call, you may want to camp the call on that telephone. The person receiving the camped call will hear Camp-On tones (two quick beeps).

1. Press or the Camp-On button (if programmed).
2. Dial the internal number of the other telephone or press its Internal Autodial button if programmed.

Announcing the active call

You are trying to send calls you have answered to co-workers who are not at their telephones. Using the Page feature, you can announce the calls over the Norstar telephones, an external loudspeaker, or both. A co-worker hearing an announcement can answer the call from the nearest Norstar telephone.

If you want your co-worker to take the call from a specific Norstar telephone:

1. Place the call on hold.
2. Using the Page feature, announce the call and the location of the telephone to which you will transfer the call.
3. Transfer the call to the appropriate Norstar telephone.

OR

Camp the call on the appropriate Norstar telephone.

If you want your co-worker to take the call on a specific line:

1. Place the call on hold.
2. Use the Page feature to announce the call and its line number.
Your co-worker can now go to the nearest Norstar telephone that has that line, select the line, and lift the receiver.

If you want your co-worker to take the call from any Norstar telephone:

1. Use the Call Park feature to place the call on hold. Your telephone shows a three-digit Call Park Retrieval code on the display.
2. Use the Page feature to announce the call and the Call Park Retrieval code.
Your co-worker can now retrieve the call from any other Norstar telephone by lifting the receiver or by pressing the button and then dialing the three-digit code.

Note: Remember that callback (the call is routed back to your Prime Telephone) occurs if your transferred, parked, or camped call goes unanswered.

Useful Norstar features

Informing your co-workers about their calls

Use the Send Message feature to notify co-workers that they should call you for information.

Display messages show you if the person you are trying to call is on another line, does not reply, or has turned on Do Not Disturb. In each case, you can use the Ring Again feature.

The Ring Again feature is a method of ensuring that you immediately know when there is a change in the use of the other telephone. You can then try again to place a call.

Working with other features

Some of the many special features which Norstar provides may be particularly useful to you. Some of these features, however, are only available if assigned during Configuration or Administration programming. Speak to your System Coordinator to determine which features you can use, and to obtain details on how to use them.

Answer Button: You can immediately answer and monitor another Norstar telephone, for example, your managers'.

Automatic Handsfree: If programmed, you can use the Handsfree microphone and speaker for all your calls.

Call Pickup Directed: Anyone in the office can answer a call ringing at any other Norstar telephone by dialing that telephone's internal number.

Call Pickup Group: Any member of a specified group can answer an external or internal call ringing at another telephone within that specified group.

Direct-Dial Telephone: If your Prime Telephone is administered as a Direct-Dial telephone, anyone assigned to your Direct Dial telephone can quickly contact you by dialing an assigned single-digit number.

Hotline: A Norstar telephone may be programmed to automatically dial your Prime Telephone when its receiver is lifted.

Page Zone: If you do not want to disturb the entire office with an announcement, you can direct the page to a choice of smaller areas.

Priority Call: If you have answered an urgent call for someone who is busy on another line, you can interrupt the person with this feature.

Other information

Some unique situations

If an external call comes to you, and you do not have a button representing the line the call is on, the indicator ► for that call will appear next to any available Intercom button on your telephone.

If your Prime Telephone receives a callback call, you will hear the Norstar ring instead of the External ring.

The Held Line Reminder or the Delayed Ring Transfer feature is not available unless assigned during Configuration programming.

If you are using all of your external line buttons and Intercom buttons, you can still receive a camped call (you will hear two quick beeps).

If your Prime Telephone is an M7324 telephone, you can monitor the busy/not busy status of other Norstar telephones. Check for the presence or absence of indicators ► beside the Internal Autodial buttons for other telephones.

Where to get help

To learn more about Norstar and its features, the System Coordinator can provide you with the following Norstar documents:

The Norstar Telephone User Cards show you how to:

- make an external call
- make an internal call
- put a call on hold
- USE Handsfree
- program memory buttons.

The *Compact DR5 Telephone Feature Card* lists the feature codes and describes the features.

The *Norstar Busy Lamp Field (BLF) User Card* describes how to use the Busy Lamp Field.

The *Norstar Central Answering Position (CAP) User Card* describes how to use Central Answering Position modules.

Your Norstar M7100 telephone

Release button _____
cancels active calls.

Display _____
shows the time, date, call information and guides you while using Norstar* features.

Memory button _____
is programmable to store a feature or to automatically dial internal or external number.

Dial pad _____

Feature button _____
starts or ends a feature.

Volume control _____

Hold button _____

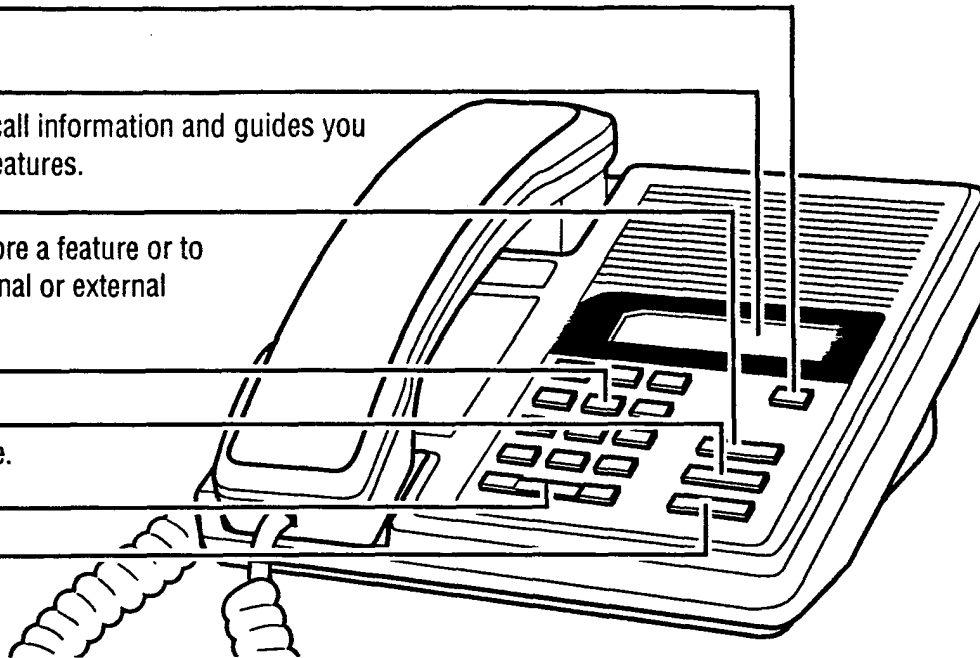

Button inquiry

Confirm that your memory button has the correct snap-on cap by checking its programming.

1. Release all calls and open lines with dial tone.
2. Press * 0 .
3. Read the display.
4. Press when finished.

Adjusting display contrast

1. Press * 7 .
2. Press to for the level you want.

Selecting a ring type and volume

1. Press * 6 .
2. Press , , or to hear the different types of rings.
3. While the telephone is ringing, press to adjust the volume.
4. Press to store the ring.

Adjusting receiver or telephone speaker volume

1. Press when using the receiver or the speaker.

* Meridian and Norstar are trademarks of Northern Telecom.

Making calls

Internal calls

1. Pick up the receiver.
2. Dial the internal number.

External calls

1. Pick up the receiver.
2. Dial (or your system's external line access code).
3. Dial the external telephone number.

Note: Internal numbers and the external access code are supplied by your System Coordinator.

Making and answering a second call

The M7100 telephone allows you to have two calls active at the same time. By using you can switch between calls.

To answer a second call while on another call

1. Press to put the first call on hold.
The second call automatically comes onto the line.

To hold a call and make a second call

1. Press to put the first call on hold.
2. Dial the telephone number for the second call.

To return to the first call

1. Press again to return to the first call on hold.
The second call is automatically put on hold.

To hold a call

1. Press .
2. Press again to return to the call on hold.
Check the display for confirmation or additional information.

Programming the memory button

About the memory button

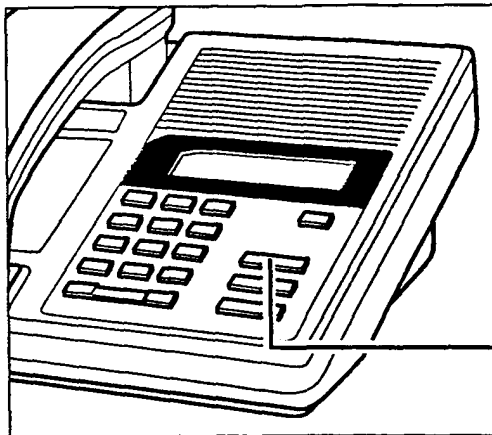

The memory button can store a telephone number or feature code to give you one touch dialing or feature activation. You can change the memory button by programming it with a new number or feature code.

Memory button

Remember: Press * to check the memory button.

Programming memory buttons

External autodial

1. If you are on a call or an open line with dial tone, press or .
2. Press * .
3. Dial the external number.
4. Press to store the number.
5. Label your new button.

Internal autodial

1. If you are on a call or an open line with dial tone, press or .
2. Press * .
3. Dial the internal number.
4. Label your new button.

Features

1. If you are on a call or an open line with dial tone, press or .
2. Press * .
3. Press and the feature code.
4. Label your new button.

Erasing memory buttons

1. If you are on a call or an open line with dial tone, press or .
2. Press * .
3. Press to erase the button.

Your Norstar M7208 telephone

Display

shows the time, date, call information and guides you while using Norstar* features.

Indicators

appear beside active lines and features.

Feature button

starts or ends a feature.

Release button

cancels active calls.

Hold button

Dial pad

Volume control

Memory and line buttons

are buttons with indicators for one touch dialing, feature operation or line access.

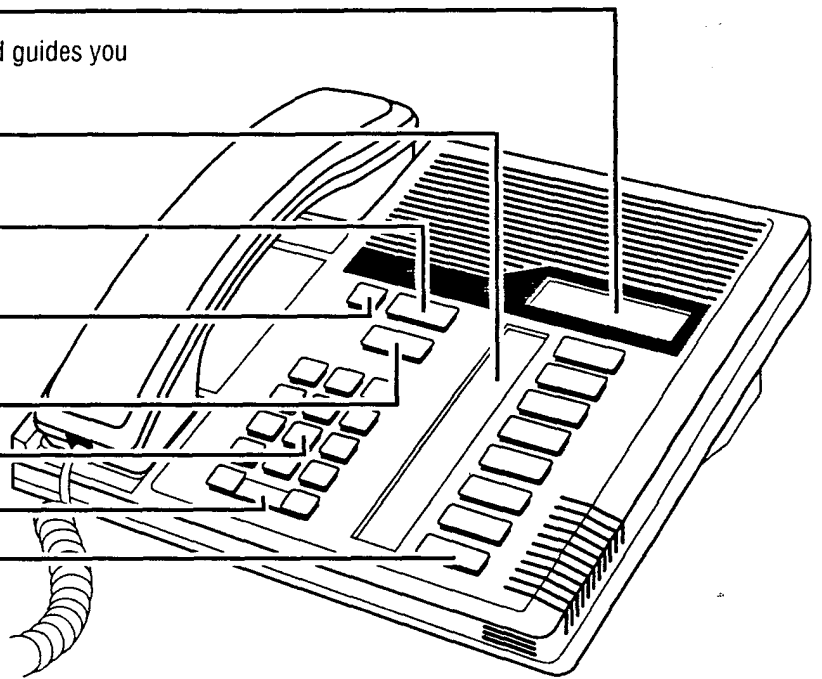

Button Inquiry

Confirm that your memory and line buttons have the correct snap-on caps by checking their programming.

1. Release all calls and open lines with dial tone.
2. Press **Feature** * 0.
3. Press the button you want to check.
4. Read the display.
5. Press **Feature** when finished.

Adjusting display contrast

1. Press **Feature** * 7.
2. Press a number on the dial pad for the contrast level you want, the higher the number the higher the contrast level.

Selecting a Ring Type and volume level

1. Press **Feature** * 6.
2. Press 1, 2, 3 or 4 to hear the different types of rings.
3. While the telephone is ringing, press **softer** **louder** to adjust the volume.
4. Press **Feature** to store the ring.

Adjusting receiver or telephone speaker volume

1. Press **softer** **louder** when using the receiver or the speaker.

* Meridian and Norstar are trademarks of Northern Telecom.

Making calls

About line buttons

Norstar systems can have different types of line buttons. Match the line buttons on your telephone with the ones below for instructions on how to use them.

Intercom

Line 1

Internal calls using Intercom buttons

1. Pick up the receiver.
2. If ► appears beside an Intercom button, then dial.

OR

Press an Intercom button without ►, then dial.

External calls using numbered Line buttons

1. Pick up the receiver.
2. When ► appears beside a numbered Line button, then dial.

OR

Press a numbered Line button without ►, then dial.

Note: Internal numbers are supplied by your System Coordinator.

4321

Internal calls using extension buttons

1. Pick up the receiver.
2. When ► appears beside an extension button, then dial.

External calls using extension buttons

1. Pick up the receiver.
2. When ► appears beside the extension button, dial (or your system's external line access code) and the number.

Hold

Holding Calls

1. Press . The ► flashes beside the line on hold.
2. Press the line button with the flashing ► to return to the call. Check the display for confirmation or additional information.

Automatic hold

Calls are put on hold automatically when you switch from one line to another.

Handsfree

This button operates the telephone's built-in microphone and speaker in place of the receiver. Your System Coordinator can program Handsfree to your telephone.

Making calls

1. Press instead of picking up the receiver.

Switching between Handsfree and handset

1. Press and replace the handset to switch to Handsfree.
2. Pick up the receiver to switch back.

Using Mute

1. Press to turn the microphone OFF.
2. Press again to turn the microphone ON.

Dialing without lifting the handset

1. Press a line button without ►, then dial your call.
2. When answered, pick up the receiver, or press .
3. If the call is not answered, or the line is busy, press .

Programming memory buttons

About memory buttons

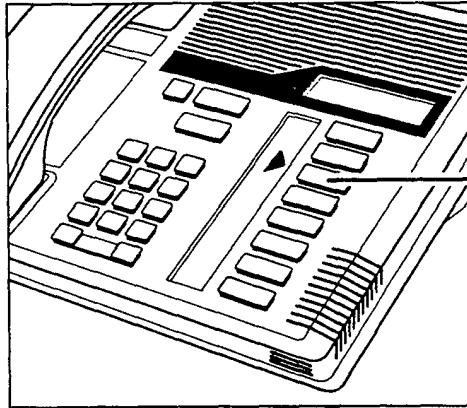

Memory buttons are the buttons with indicators other than line or Handsfree buttons. Memory buttons store telephone numbers or feature codes to give you one touch dialing or feature activation. You can change what a memory button does by just programming it with a new number or feature. You cannot program a line or Handsfree button.

Remember: Press * to check a memory or line button.

Programming memory buttons

External autodial

1. If you are on a call or an open line with dial tone, press or .
2. Press * .
3. Press a memory button.
4. Dial the external number.
5. Press to store the number.
6. Label your new button.

Internal autodial

1. If you are on a call or an open line with dial tone, press or .
2. Press * .
3. Press a memory button.
4. Dial the internal number.
5. Label your new button.

Features

1. If you are on a call or an open line with dial tone, press or .
2. Press * .
3. Press a memory button.
4. Press and the feature code.
5. Label your new button.

Erasing memory buttons

1. If you are on a call or an open line with dial tone, press or .
2. Press * .
3. Press the memory button you want to erase.
4. Press to erase the button.

Your Norstar M7310 telephone

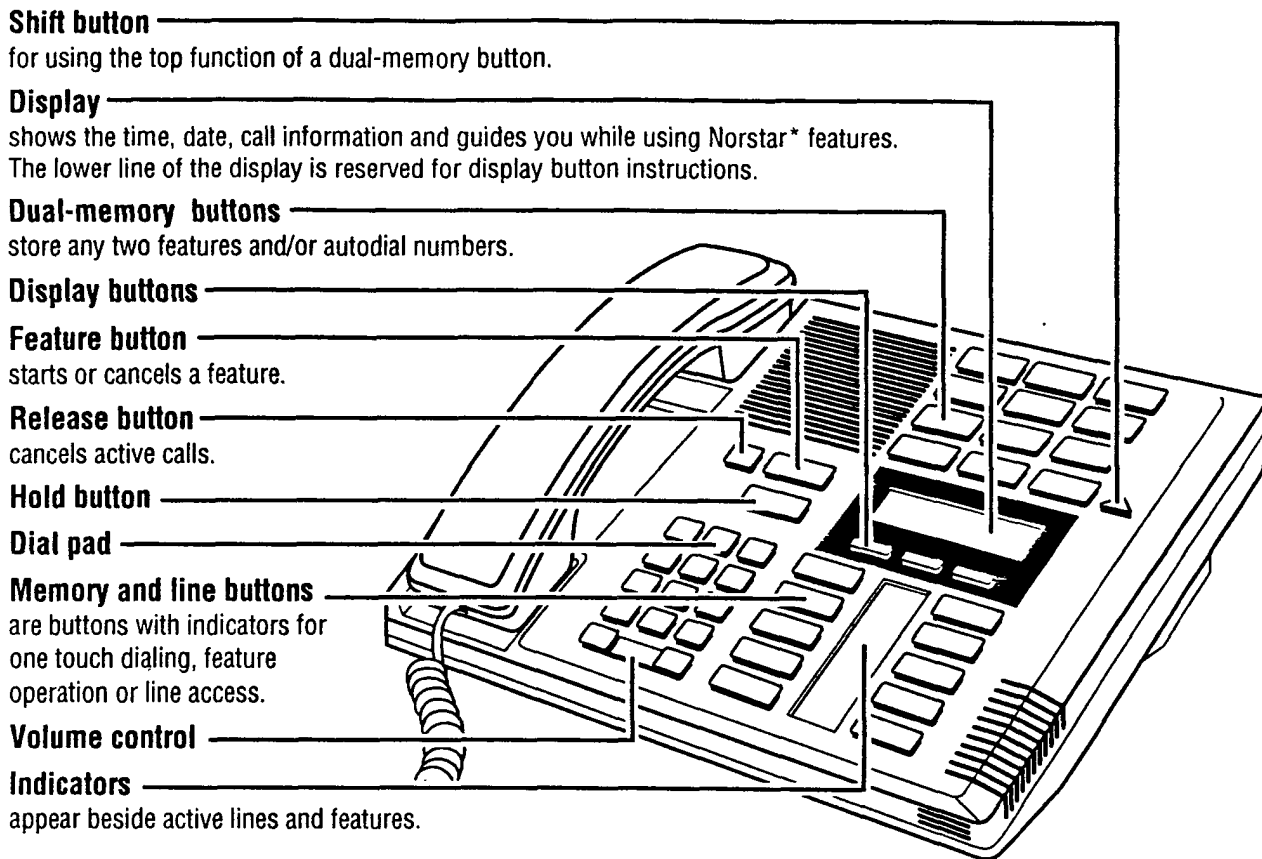

Using display buttons

Display buttons change with each feature you use. The labels for display buttons appear in capital letters directly above them on the second line of the display. A display button with an "OK" label above it is represented as **OK** in this card.

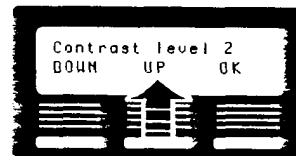

Button inquiry

Confirm that your memory and line buttons have the correct snap-on caps by checking their programming.

1. Release all calls or open lines with dial tone.
2. Press **Feature** * 0 .
3. Press the button(s) you want to check and read the display.
4. Press **Feature** when finished.

Adjusting display contrast

1. Press **Feature** * 7 .
2. Press **UP** or **DOWN** for the level you want.
3. Press **OK** when finished.

Selecting a ring type and volume level

1. Press **Feature** * 6 .
2. Press 1, 2, 3 or 4 to hear the different types of rings.
3. While the telephone is ringing, press **softer** or **louder** to adjust the volume.
4. Press **OK** to store the ring.

* Meridian and Norstar are trademarks of Northern Telecom.

Making calls

About line buttons

Norstar systems can have different types of line buttons. Match the line buttons on your telephone with the ones below for instructions on how to use them.

Intercom

Line 1

Internal calls using Intercom buttons

1. Pick up the receiver.
2. If ► appears beside an Intercom button, then dial.
OR
Press an Intercom button without ►, then dial.

External calls using numbered Line buttons

1. Pick up the receiver.
2. When ► appears beside a numbered Line button, then dial.
OR
Press a numbered Line button without ►, then dial.

Note: Internal numbers are supplied by your System Coordinator.

4321

Internal calls using extension buttons

1. Pick up the receiver.
2. When ► appears beside an extension button, then dial.

External calls using extension buttons

1. Pick up the receiver.
2. When ► appears beside the extension button, then dial (or your system's external line access code) and the number.

Hold

Holding Calls

1. Press . The ► flashes beside the line on hold.
2. Press the line button with the flashing ► to return to the call.
Check the display for confirmation or additional information.

Automatic hold

Calls are put on hold automatically when you switch from one line to another.

Handsfree

This button operates the telephone's built-in microphone and speaker in place of the receiver. Your System Coordinator can program Handsfree to your telephone.

Making calls

1. Press instead of picking up the receiver.

Switching between Handsfree and handset

1. Press and replace the handset to switch to Handsfree.
2. Pick up the receiver to switch back.

Using Mute

1. Press to turn the microphone OFF.
2. Press again to turn the microphone ON.

Dialing without lifting the handset

1. Press a line button without ►, then dial your call.
2. When answered, pick up the receiver, or press .
3. If the call is not answered, or the line is busy, press .

Programming memory buttons

About memory buttons

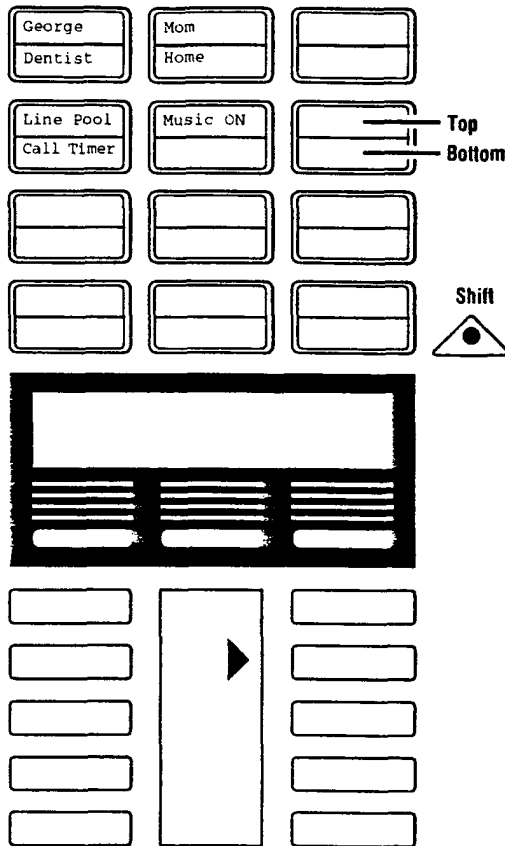

There are two types of memory buttons: single-memory and dual-memory. Memory buttons store telephone numbers or feature codes to give you one touch dialing or feature activation.

Dual-memory buttons

To use the **bottom** function, press the dual-memory button.

To use the **top** function, press the shift button, then press the dual-memory button.

Single-memory buttons

Single-memory buttons are the buttons with indicators other than line or Handsfree buttons.

Remember: Press * to check a memory or line button.

Programming memory buttons

External autodial

1. If you are on a call or an open line with dial tone, press or .
2. Press * .
3. Press a memory button.
4. Dial the external number.
5. Press **OK** to store the number.
6. Label your new button.

Internal autodial

1. If you are on a call or an open line with dial tone, press or .
2. Press * .
3. Press a memory button.
4. Dial the internal number.
5. Label your new button.

Features

1. If you are on a call or an open line with dial tone, press or .
2. Press * .
3. Press a memory button.
4. Press and the feature code.
5. Label your new button.

Erasing memory buttons

1. If you are on a call or an open line with dial tone, press or .
2. Press * .
3. Press the memory button you want to erase.
4. Press **OK** to erase the button.

Your Norstar M7324 telephone

Memory and line buttons

are buttons with indicators for one touch dialing, feature operation or line access.

Display

shows the time, date, call information and guides you while using Norstar* features. The lower line of the display is reserved for display button instructions.

Display buttons

Dial pad

Volume control

Feature button

starts or ends a feature.

Hold button

Release button

cancels active calls.

Indicators

appear beside active lines and features.

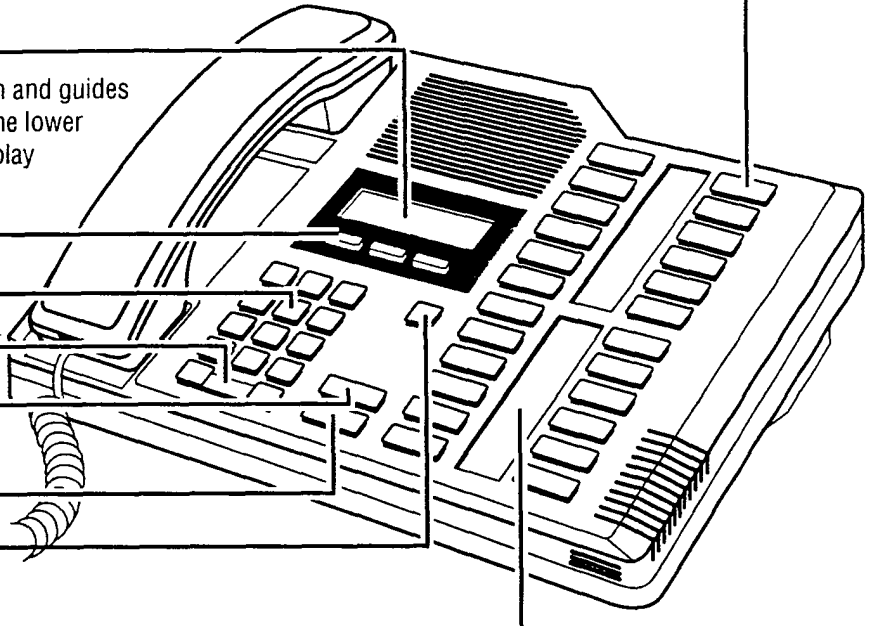

Using display buttons

Display buttons change with each feature you use. The labels for display buttons appear in capital letters directly above them on the second line of the display. A display button with an "OK" label above it is represented as OK in this card.

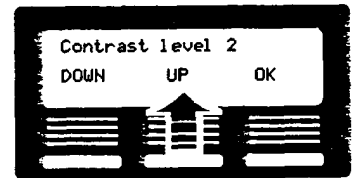

Button inquiry

Confirm that your memory and line buttons have the correct snap-on caps by checking their programming.

1. Release all calls or open lines with dial tone.
2. Press * 0 .
3. Press the button(s) you want to check and read the display.
4. Press when finished.

Adjusting display contrast

1. Press * 7 .
2. Press UP or DOWN for the level you want.
3. Press OK when finished.

Selecting a ring type and volume level

1. Press * 6 .
2. Press , , , or to hear the different types of rings.
3. While the telephone is ringing, press to adjust the volume.
4. Press OK to store the ring.

* Meridian and Norstar are trademarks of Northern Telecom.

Making calls

About line buttons

Norstar systems can have different types of line buttons. Match the line buttons on your telephone with the ones below for instructions on how to use them.

Intercom

Line 1

Internal calls using Intercom buttons

1. Pick up the receiver.
2. If ► appears beside an Intercom button, then dial.
OR
Press an Intercom button without ►, then dial.

External calls using numbered Line buttons

1. Pick up the receiver.
2. When ► appears beside a numbered Line button, then dial.
OR
Press a numbered Line button without ►, then dial.

Note: Internal numbers are supplied by your system coordinator.

4321

Internal calls using extension buttons

1. Pick up the receiver.
2. When ► appears beside an extension button, then dial.

External calls using extension buttons

1. Pick up the receiver.
2. When ► appears beside the extension button, then dial (or your system's external line access code) and the number.

Hold

Holding Calls

1. Press . The ► flashes beside the line on hold.
2. Press the line button with the flashing ► to return to the call.
Check the display for confirmation or additional information.

Automatic hold

Calls are put on hold automatically when you switch from one line to another.

Handsfree

This button operates the telephone's built-in microphone and speaker in place of the receiver. Your System Coordinator can program Handsfree to your telephone.

Making calls

1. Press instead of picking up the receiver.

Switching between Handsfree and handset

1. Press and replace the handset to switch to Handsfree.
2. Pick up the receiver to switch back.

Using Mute

1. Press to turn the microphone OFF.
2. Press again to turn the microphone ON.

Dialing without lifting the handset

1. Press a line button without ►, then dial your call.
2. When answered, pick up the receiver, or press .
3. If the call is not answered, or the line is busy, press .

Programming memory buttons

About memory buttons

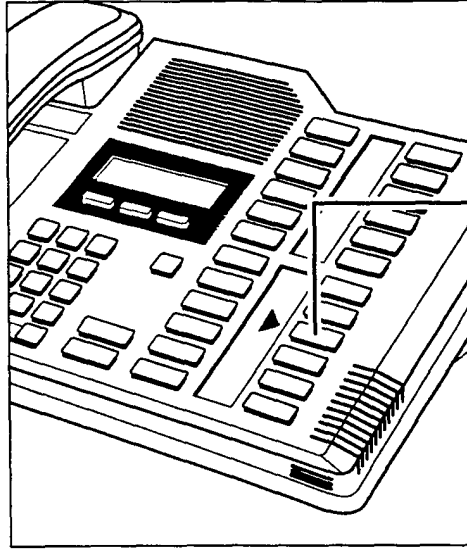

Memory buttons are the buttons with indicators other than line or Handsfree buttons. Memory buttons store telephone numbers or feature codes to give you one touch dialing or feature activation. You can change what a memory button does by just programming it with a new number or feature.

If you have programmed a memory button with an internal number the indicator comes on when the number is busy.

Remember: Press * to check a memory or line button.

Programming memory buttons

External autodial

1. If you are on a call or an open line with dial tone, press or .
2. Press * .
3. Press a memory button.
4. Dial the external number.
5. Press **OK** to store the number.
6. Label your new button.

Internal autodial

1. If you are on a call or an open line with dial tone, press or .
2. Press * .
3. Press a memory button.
4. Dial the internal number.
5. Label your new button.

Features

1. If you are on a call or an open line with dial tone, press or .
2. Press * .
3. Press a memory button.
4. Press and the feature code.
5. Label your new button.

Erasing memory buttons

1. If you are on a call or an open line with dial tone, press or .
2. Press * .
3. Press the memory button you want to erase.
4. Press **OK** to erase the button.

A

Access code: A sequence of characters used to gain entry into any type of Norstar system programming.

Administration: A program that lets one person in your office (the System Coordinator) assign and maintain certain settings for the Norstar system.

Administration access code:
A code required to access Administration programming. You may be asked for an Administration password.

Administration password: A one to six-digit password that prevents unauthorized access to Administration programming. The Administration password can be assigned and changed in Administration programming.

Allow redirect: A setting in Administration programming that enables you to identify whether a telephone is allowed access to the Line Redirection feature. Allow redirect has no effect if Disconnect Supervision is unavailable or was not enabled by your Customer Service representative.

Analog Terminal Adapter (ATA): A device that permits the connection of analog telecommunication devices such as fax machines, answering machines, and single line telephones to the Norstar system. Programmed defaults for the ATA are automatically assigned by the Norstar system.

Answer button: A telephone button with an indicator that is used to monitor another telephone. The Answer button indicates incoming calls destined for the other telephone. Someone working at a telephone with Answer buttons (a receptionist, for example) can receive all ringing and visual indication of incoming calls for other telephones, and answer those calls when necessary. One telephone can have up to four Answer buttons. An Answer button is automatically assigned to a telephone when that telephone is assigned an Answer DN.

Answer DN: A Directory Number (DN) of a telephone that is monitored by an Answer button. Up to four Answer DNs can be assigned to a telephone by the Customer Service representative.

Autobumping: A setting that determines what the system does with new Call Log items when your Call Log is full. When Autobumping is on, a new log entry causes the oldest entry to be deleted. If Autobumping is off, your Norstar system does not log calls when your log is full.

Autodial button: A memory button that, if programmed, provides one-touch dialing of external or internal numbers.

Automatic Dial: A feature that allows you to dial without having to pick up the receiver or select a line. You must have a Prime line to use Automatic Dial.

Automatic Handsfree: A feature that automatically activates Handsfree operation when you make or answer a call. Automatic Handsfree is assigned in Administration programming.

Automatic Hold: A feature that automatically places an active call on hold when you select another line. Automatic Hold is programmed by your Customer Service representative.

Automatic Telephone

Relocation: A feature that lets a telephone retain its personal and system programming when it is plugged into a different Norstar modular jack. Automatic telephone relocation is enabled by your Customer Service representative.

Auxiliary ringer: A separate external telephone ringer or bell that can be programmed to ring when a line or a telephone rings. An auxiliary ringer may be programmed to ring only when the system is in a particular Service Mode. Programming of an auxiliary ringer is done in Administration programming after the feature has been enabled by your Customer Service representative.

B

Background Music: A feature that lets you hear music from the speaker of your Norstar telephone. It is available only if a music source has been attached to the KSU and the feature has been enabled by your Customer Service representative.

Busy Lamp Field (BLF): A device with a liquid crystal display (LCD) panel of indicators that shows the status of up to 24 telephones in the Norstar system. The BLF shows a telephone as busy if it is active on a call, has Do Not Disturb turned on, or is being used for programming. The BLF attaches to the M7310 Telephone.

Button caps: Interchangeable plastic caps that fit over the buttons of Norstar telephones. They are used to indicate the features programmed onto each programmable memory button. Button caps are either pre-printed or have clear windows that allow you to label the buttons.

Button Inquiry: A feature that allows you to check the function of each programmable button on your Norstar telephone.

Bypass Restrictions: A setting that allows you to override any Call Restrictions applied to specific System Speed Dial numbers. Bypass Restrictions can be turned on in Administration programming.

C

Call Forward: A feature that forwards all the calls arriving at your telephone to another telephone in your Norstar system. To have calls forwarded outside the system, use Line Redirection.

Call Forward No Answer: A feature that forwards all calls arriving at your telephone to another designated telephone in your Norstar system after a specific number of rings. Call Forward No Answer is assigned in Administration programming.

Call Forward On Busy: A feature that forwards all calls at your telephone to another designated telephone if your telephone is busy. This feature is assigned in Administration programming.

Call Forward Override: A feature that allows you to call someone and ask them to stop forwarding their calls to you.

Call Information: A feature that allows you to display information about incoming calls. For external calls, you can display the caller's name, telephone number and the line name. For an internal call, you can display the name of the caller and their internal number. You can obtain information about ringing, answered, or held calls.

Call Log: A feature that accesses a record of incoming calls. The log could contain the following information for each call: sequence number in the Call Log, name and number of caller, long distance indication, indication if the call was answered, time and date of the call, number of repeated calls from the same source, and name of the line that the call came in on. See Autobumping, Enter Call Log, Logit, and Logging Options for further information.

Call Park: A feature that allows you to place a call on hold so that someone can retrieve it from any telephone in the Norstar system by selecting an internal line and entering a retrieval code. The retrieval code appears on the display of your telephone when you park the call. You can park up to two calls on the system at one time.

Call Park Callback: See Callback.

Call Park prefix: The first digit of the retrieval code of a parked call. The default Call Park prefix digit is "1". It may be set to none, in which case Call Park is disabled. Call Park prefix is assigned by your Customer Service representative.

Call Pickup Directed: A feature that lets you answer a call ringing at any Norstar telephone by entering the internal number of that telephone before taking the call. Call Pickup Directed is activated by your Customer Service representative.

Call Pickup group: See Pickup group.

Call Queuing: A feature that allows you to answer calls in order of priority if you have several calls waiting at your telephone. Priority is given to external incoming calls, followed by callback and camped calls.

Callback: A feature that returns parked, camped or transferred calls to your telephone if they are not answered at another telephone. How long the system will wait before Callback occurs is set by your Customer Service representative.

Camp-On: A feature that lets you re-route a call to a telephone even if all the lines on that telephone are busy. To answer a camped call, use Call Queuing or select a line if the camped call appears on your telephone. Priority is given to queued external incoming calls over camped calls.

Camp timeout: The length of a delay before a camped call is returned to the telephone that camped the call. This delay is set by your Customer Service representative.

Capabilities: A section heading in Administration programming, that covers the dialing filters, set abilities, and line abilities that can be assigned to Norstar lines, telephones, or Class of Service passwords.

Central Answering Position (CAP) module: A CAP module is connected to an M7324 Telephone and provides 48 additional buttons which can be used as Autodial buttons or Feature buttons.

Class of Service (COS): A set of Norstar features and lines available to the user for a call. The Class of Service for a call is determined by the Dialing Filters assigned to the telephone in Administration programming. The Class of Service for a call can be changed by entering a six-digit Class of Service password. Class of Service and Class of Service passwords are assigned in Administration programming.

Class of Service password: A six-digit code that lets you switch from your current Class of Service to one that lets you dial numbers prohibited by your current Class of Service.

Conference: A feature that allows you to establish a three-person call at your Norstar telephone.

Conference using Privacy: A feature that allows you to turn Privacy off for a call allowing another person with the same line to press the line button and join in your conversation, forming a conference. Normally your calls are private; no one else can pick up your line and join in.

Contrast Adjustment: A feature that allows you to set the contrast level of your telephone display.

Control telephone: A telephone that can place the lines for which it has responsibility in or out of a Service Mode. A telephone is programmed as a Control telephone and has lines assigned to it in Administration programming.

COS: See Class of Service.

Cursor: A short horizontal line that appears on the Norstar telephone display to indicate that characters can be entered using the dial pad.

D

Data Communications

Interface: A Norstar device that lets you attach an RS-232 data device to your Norstar system.

Data terminal: A device, such as a modem, that can be used to transfer data instead of sound over a telephone network. You cannot use Norstar programming to set up such devices. See the documentation that accompanies the device.

Date: See Show Time or Time and Date.

DCI: See Data Communications Interface.

Defaults: The settings for all Norstar features when the system is first installed. Settings are changed from their defaults in Administration programming and by your Customer Service representative. In this manual, default settings are shown in **bold text**.

Delayed Ring Transfer (DRT) to Prime: A feature that transfers an unanswered call on an external line to the Prime Telephone associated with that line after a specified number of rings. This feature is activated by your Customer Service representative.

Dialing mode: The dialing mode of a line can be either tone or pulse. Pulse is traditionally used by rotary dial telephones. Tone is also referred to as dual-tone multi frequency (DTMF) tones. Dial mode can be programmed by your Customer Service representative.

Dialing filter: A feature that prevents certain telephone numbers from being dialed through a combination of restrictions and exceptions. Dialing filters can be applied to telephones (set filters), to lines (line filters), to specific lines on a telephone (line/set filters), and to Class of Service passwords. The Norstar Compact system can handle up to 25 dialing filters.

Direct-dial: A feature that lets you dial a designated telephone in your Norstar system with a single digit. The Direct-dial telephone is established in Administration programming. Telephones are assigned to a Direct-dial telephone in Administration programming.

Direct-dial number: A digit used system wide to call a Direct-dial telephone. The digit is programmed by your Customer Service representative.

Directed Pickup: See Call Pickup Directed.

Directory Number (DN): A unique number that is assigned to each telephone or data terminal by your Customer Service representative. The DN, also referred to as an internal number, is often used to identify a telephone when settings are assigned during programming.

Disconnect Supervision: A setting which enables the Norstar system to detect if an external caller hangs up. Once an external caller hangs up, the Norstar system can disconnect its line. Disconnect Supervision is enabled by your Customer Service representative. If Disconnect Supervision is unavailable or is not enabled the following features are not available: Line Redirection of an external call to an external number, Transfer between two external calls and Unsupervised Conference between two external calls.

Display: A liquid crystal display (LCD) on the Norstar telephone that guides you through feature operation and programming.

Display button: One of three buttons located directly beneath the display on M7310 and M7324 Telephones. During feature operation or programming, some or all of these buttons may be used to provide further options. If an option is available, it is shown in the bottom line of the two-line display, directly above the corresponding display button. Display buttons are represented in this Guide as underlined capitals, e.g. OK.

Display digits: A sub-heading in Administration programming that allows you to set whether an assigned name or the actual number is displayed when someone uses a System Speed Dial code.

DN: See Directory Number.

DRT delay: The number of rings before a Delayed Ring Transfer occurs. This is assigned by your Customer Service representative.

DRT to Prime: See Delayed Ring Transfer to Prime.

E

Emergency Telephone: A single-line telephone (also referred to as a 500/2500 telephone) that becomes active when there is no power to the Key Service Unit.

Exceptions: A component of a Dialing filter. Exceptions are numbers you can dial even if they are forbidden by a more general restriction. See Restrictions.

External call: A call to a destination outside the Norstar system.

External Call Forward: See Line Redirection.

External code: The number you dial to get an external line. The default is 9, but this can be changed by your Customer Service representative. You do not always need an external code. It is primarily to support the M7100 Telephone and single-line telephones using an Analog Terminal Adapter (ATA).

External line: A line on your Norstar telephone used for making calls to destinations outside the Norstar system.

External music source: See Music source.

External paging: A feature you can use to make voice announcements over an externally-mounted loudspeaker connected to the Key Service Unit. The external speaker is not a Norstar component and must be supplied by the customer.

Extra-dial telephone: A heading in Administration programming that allows you to assign an extra Direct-dial telephone when a Service Mode is active. You can have one Extra-dial telephone-for each of the three Service Modes.

F

Feature button: A button that activates many Norstar features when it is pressed and followed by a feature code. The Feature button is also used to exit a feature.

Feature code: A number that is used to activate a particular feature.

Forward: See Call Forward.

Forward delay: The number of rings before an unanswered call is forwarded to another telephone when the Call Forward No Answer feature is on. Forward delay is assigned in Administration programming.

Forward No Answer: See Call Forward No Answer.

Forward On Busy: See Call Forward On Busy.

Full Autohold (on idle line): When this feature is activated, selecting an available line and then selecting another line, puts the first line on hold. Full Autohold is activated by your Customer Service representative.

Full Handsfree: See Handsfree.

G

Group Listen: A feature that allows you to have others in your office hear a caller through your phone's speaker. The caller hears you only when you speak into the receiver and cannot hear other people in the office.

H

Handsfree: A feature you can use to make calls without using the telephone receiver. Full Handsfree is activated in Administration programming. When it is activated, a Handsfree/Mute button is automatically assigned to the telephone.

Handsfree (HF) Answerback: A feature that automatically turns on the microphone at a telephone receiving a Voice Call so that the person receiving the call can respond without lifting the receiver. Handsfree Answerback is activated in Administration programming.

Handsfree/Mute button: See Handsfree.

Headset: A head-mounted or ear-mounted telephone receiver that is used instead of the hand-held receiver. Headsets are not Norstar components and must be supplied by the customer.

Held (line) Reminder: An indication that an external call has been placed on hold for a certain period of time. Your Norstar telephone beeps and displays the message **On hold: LINENAM**. The Held (line) Reminder feature and Remind delay are programmed by your Customer Service representative.

HF Answerback: See Handsfree Answerback.

Hold button: A button used to suspend calls so that the person using the telephone can perform another task without disconnecting the caller.

Hookswitch Flash: See Link time.

Host System Signaling: (Also referred to as End-to-End Signaling.) Norstar telephones can access a remote system or dial a number on an alternate carrier by means of Host feature activation, such as Link, Pause and Run/Stop.

Hotline: A feature that automatically calls a pre-assigned number when the telephone's receiver is lifted or the Handsfree/Mute button is pressed. A Hotline number can be an internal or external number. Hotline is programmed in Administration programming.

Hung line: A line that remains busy after a redirected call is over. A hung line is indicated when a line indicator is solid for a long time and a call is not in progress. Hung lines can be cleared at the telephone that was used to redirect the line.

I

IC: An abbreviation of Intercom button.

Installer: A person who installs the Norstar equipment, and performs System Startup and certain programming actions. The Installer or the System Coordinator can program Administration settings.

Intercom button: A button that provides access to internal lines used for calls within a Norstar system and access to external lines through a Line Pool or external code. A telephone may be assigned zero, one or two Intercom buttons. This is done by the Customer Service representative.

Intercom keys: See Intercom button.

Internal line: A line on your telephone dedicated to making calls to destinations inside your Norstar system. An internal line may still connect you with an external caller if you use it to access a line pool or to pick up a call using Norstar call handling features such as Call Park or Call Pickup Directed.

Internal number: A number (also referred to as a Directory Number or DN) that identifies a Norstar telephone or device.

Internal user: A person using a Norstar telephone within a Norstar system.

K

Key Service Unit (KSU): The central hardware component in the Norstar system. The KSU has its own processor and memory, and provides a physical point of connection for the various types of devices and telephones used in Norstar. The KSU supports 16 Norstar telephones and 6 external lines.

L

Line: The complete path of a voice or data connection between one telephone (or other device) and another.

Line abilities: The heading in Administration programming under which you assign Line filters to lines.

Line filter: See Dialing filter.

Line names: The sub-heading in Administration programming that allows you to assign names to external lines.

Line number: A 2-digit number that identifies an external line.

Line Pool: A group of lines used for making external calls. Line Pools provide an efficient way of giving a telephone access to external lines without taking up many line buttons. A line is assigned to be a member of a Line Pool by your Customer Service representative.

Line Pool access code: A number that gains access to a specific Line Pool if you are a member of that Line Pool. Line Pool access codes are assigned by your Customer Service representative.

Line Redirection: A feature that allows you to redirect all external calls on an incoming line to a destination outside the Norstar system. Once a line is redirected it cannot be answered within the Norstar system. The system may be set up to give a brief ring when a call comes in on a redirected line. Line Redirection must be assigned to your telephone in Administration programming. When redirecting an external call to an external number, the incoming call must be on a disconnect supervised line. See Allow Redirect, Call Forward, Disconnect Supervision and Redirect Ring.

Link time: A specific time delay that allows access to PBX features through a Norstar system. Link time is also referred to as a "Hookswitch Flash" or "Recall". Link time is assigned by your Customer Service representative.

Logging Options: A feature that allows you to select the type of calls that are stored in your Call Log. You can choose to log calls that were not answered by anyone within the system, to log calls that were unanswered at this telephone but answered elsewhere in the system, to log all calls answered and not answered at this telephone, or to not have calls automatically logged.

Logit: A feature that allows you to manually log call information when you are connected to a call.

Long Tones: A feature that lets you control the length of a tone so that you can signal devices such as fax or answering machines which require tones longer than the standard 120 milliseconds.

M

M7100 Telephone: A telephone that has a one-line display and * one programmable memory button without an indicator.

M7208 Telephone: A telephone that has a one-line display and eight programmable memory buttons with indicators.

M7310 Telephone: A telephone that has a two-line display, 3 display buttons, 10 programmable memory buttons with indicators, and 12 dual-memory programmable buttons without indicators. An M7310 Telephone can be equipped with a Busy Lamp Field.

M7324 Telephone: A telephone with a two-line display, 3 display buttons, and 24 programmable memory buttons with indicators. An M7324 Telephone can be equipped with a CAP module.

M7900 Telephone: A telephone with a touch-screen display that replaces the display and memory buttons of other Norstar telephones. It provides simplified access to Norstar Features and an interface to computer driven applications.

Memory buttons: The buttons that can be programmed to dial frequently used features or numbers automatically. See M7100, M7208, M7310, M7324 and M7900 Telephone entries for their exact memory button configurations.

Message: A feature that allows you to indicate to another internal user that you would like them to call you.

Music source: A radio or other source of music that can be connected to the Key Service Unit to provide music for the Music on Hold and Background Music features. A music source is not part of the Norstar system and must be supplied by the customer.

N

Names: A feature that allows you to assign names to System Speed Dial numbers, external lines, telephones, and Service Modes in Administration programming. You can use up to sixteen characters to name a System Speed Dial number, and seven characters to name a telephone, line, or Service Mode. If a Name has not been assigned, the line number or DN appears on the display instead of a Name.

Night Service: See Service Modes.

Norstar Programming

Overlay: A paper template that is placed over the buttons of the Norstar telephones during programming. The overlay for the M7310 and M7324 Telephones is placed over the top four memory buttons with indicators. The overlay for the M7208 Telephone is placed over all of the eight memory buttons. The overlay labels indicate the special function that each of the buttons takes on during programming.

O

On hold: A setting that controls whether external callers hear music, periodic tones, or silence when they are placed on hold. This setting is programmed by your Customer Service representative.

Open Switch Interval (OSI): A public telephone system feature that indicates when an external line is open. Norstar monitors the length of the OSI to detect when an external caller hangs up. OSI must be provided by the public telephone system in order for Disconnect Supervision to function. See Disconnect Supervision.

Overlay: See Norstar Programming Overlay.

P

Page: A feature you can use to make announcements over the Norstar system. You can choose Internal Page (announce over the telephone speakers), External Page (announce over an externally-mounted, customer-supplied loudspeaker), or both Internal and External Page.

Page Zone: An area in the office that receives internal Page announcements independently of the rest of the office. Each Page Zone is identified by a number. Telephones are assigned to Page Zones in Administration programming.

Park prefix: See Call Park prefix.

Park timeout: A delay before an unanswered parked call returns to the telephone that parked it. Park timeout is set by your Customer Service representative. See Call Park.

Password: A specific sequence of digits that you enter to gain access to Norstar programming or to override dialing restrictions. Passwords are also required for System Startup and Administration programming. See Class of Service password.

Pause: A system feature that allows you to set a 1.5-second delay in a dialing sequence programmed on an External Autodial.

Personal Speed Dial: A two-digit code (71-94) that can be programmed to dial external telephone numbers. Personal Speed Dial numbers are programmed for each telephone, and can be used only at the telephone on which they are programmed.

Pickup group: A group of telephones. A telephone can be placed into one of four Call Pickup groups. A call ringing at a telephone within a Pickup group can be picked up at any other telephone within the same Pickup group. A telephone is assigned to a Pickup group in Administration programming.

Pool: See Line Pool.

Pre-dial: A feature that allows you to enter a number and check it on your telephone display before it is actually dialed. If the number is incorrect, you can edit it. The number is dialed only when you pick up the receiver or select a line.

Prime line: A line on your telephone that is automatically selected when you lift the receiver, press the Handsfree/Mute button or use an external dialing feature. A Prime line is assigned to a telephone by your Customer Service representative.

Prime telephone (Prime set): A telephone that provides backup answering for incoming calls on external lines. The Prime telephone for a line will ring for any unanswered calls on that line. A Prime telephone is assigned to a line by your Customer Service representative.

Priority Call: A feature you can use to interrupt calls or override Do Not Disturb on another Norstar telephone. This feature is enabled for a telephone in Administration programming.

Privacy: A feature that determines whether a Norstar user may select a line in use at another telephone and join an established call. Privacy is set by your Customer Service representative, but can be turned on and off by users during individual calls.

Private line: See Private to.

Private network: A telephone network consisting of owned or leased telephone lines used to connect different offices of an organization independently of the public network.

Private to: A line assigned to one telephone as a Private line by your Customer Service representative. The line cannot appear on any other telephone, except the Prime telephone for that line. Private lines cannot be placed into Line Pools.

Programming: A series of procedures that set the way the Norstar system works. Programming includes system-wide settings and individual telephone and line settings.

Programming Overlay: See Norstar Programming Overlay.

Programming reminder: A chart on which you can record some commonly-used settings to distribute to all Norstar telephone users.

Public line: An external line that can be assigned to any telephone and to many telephones. A line is assigned as Public by your Customer Service representative.

Public network: The regular telephone network that connects most homes and businesses.

R

Recall: See Link time.

Receiver: The handset of a telephone.

Redirect ring: A setting in Administration programming that allows you to set whether a line that has been redirected using Line Redirection gives a short ring on those telephones on which the line has a ringing appearance.

Remind delay: A feature that causes a telephone to beep and display the message

On hold: LINENAM when a call has been on hold for a programmable period of time. This period is the Remind delay, and is programmed by your Customer Service representative.

Restrictions: A component of a Dialing filter. Restrictions are numbers you cannot dial when that Dialing filter is in effect. See Exceptions.

Ringing: A programming function done by your Customer Service representative that assigns a line to ring or not ring at a telephone. If a line has been assigned as "No ring", an incoming call is shown only by a flashing indicator.

Ringing Telephone (Ringing Set): A telephone that has been assigned to ring when a line has been placed into a Service Mode. The Ringing Telephone is assigned in Administration programming.

Rls button: A button that ends a call in the same way that hanging up the receiver does. It may also be used to end Startup, Administration programming, Configuration programming and feature operations.

Run/Stop: A character that creates a breakpoint in a programmed external dialing sequence. When you press a programmed key, the system dials the number up to the Run/Stop. When you press it again, the system dials the digits following the Run/Stop.

S

SAPS: See Station Auxiliary Power Supply.

Selective Line Redirection:
See Line Redirection.

Service Modes: A feature that provides special ringing and telephone access after normal office hours, or when there are few people available to answer calls. Certain features become active when one or more lines are placed into a Service Mode. Service Modes settings are assigned in Administration programming.

Set: A telephone.

Set ability: A sub-heading in Administration programming under which set filters, line/set filters, and a variety of system features are assigned to individual telephones.

Set Copy: A programming section that allows your Customer Service representative to copy programmable settings from one telephone to another of the same type. Set Copy provides two options: duplicating System Data and User Data, or duplicating System Data only. Set Copy does not provide the same copy capability as the **COPY** display button, which is more selective of the settings that can be duplicated.

Set filter: See Dialing filter.

Set Names: A sub-heading in Administration programming that allows you to assign Names of up to seven characters to telephones.

Set Relocation: See Automatic Telephone Relocation.

Shift button: A small triangular button beside the dual-memory buttons on the upper half of the M7310 Telephone. Press the shift button to store or access features on the top half of the dual-memory buttons.

Show Time: A feature that allows you to see the current date and time on the Norstar telephone display while you are on a call.

Software Cartridge: A replaceable cartridge containing the Norstar features. The Software Cartridge is inserted into the Key Service Unit.

Station Auxiliary Power Supply (SAPS): A device which provides power to a Norstar telephone that is connected more than 305 m (1000 ft) and less than 760 m (2500 ft) from the Key Service Unit, or to a CAP module.

Supervised line: A line for which disconnect supervision is enabled. If an external caller hangs up, the Norstar system detects the disconnection and hangs up its line also. See Disconnect Supervision.

System Coordinator: A person responsible for customizing the Norstar system through Administration programming and for helping co-workers use the Norstar system.

System Data: An option in Set Copy programming. System Data refers to the system settings that apply to all telephones and lines. System Data consists of the programmable settings from Administration programming and also includes the settings programmed by your Customer Service representative.

System Speed Dial Code: A two-digit code (01 to 70) that can be programmed to dial a telephone number up to 24 digits long. System Speed Dial codes are programmed for the entire Norstar system in Administration programming.

System Speed Dial Name: A sub-heading in Administration programming under which you can assign a name to a System Speed Dial number.

System Speed Dial: A heading in Administration programming under which you can assign up to 70 numbers as System Speed Dial numbers.

System Startup: A procedure that initializes the system programming to defaults. When a Norstar system is first installed and powered up, System Startup must be performed before any programming can be done.

T

TCM line (Time Compression Multiplexing line): A two-wire digital station loop joining the cross-connect at the Key Service Unit to a telephone.

Telephone lock (Set lock): A feature that allows you to limit the number of features that may be used or programmed at a telephone. Full telephone lock allows very few changes or features, Partial telephone lock allows some changes and features, and No telephone lock allows any change to be made and any feature to be used. Telephone lock is assigned in Administration programming.

Time and Date: A display description. The current time and date appear on the display of idle Norstar telephones. The time and date can be changed in Administration programming.

Transfer: A feature that lets you send a call to another telephone in your Norstar system or external to Norstar. You can also create an Unsupervised Conference to do an external transfer. When transferring an external call to an external number, at least one of the calls must have been an incoming call, and that call must be on a disconnect supervised line. See Unsupervised Conference and Disconnect Supervision.

Transfer Callback: A feature that returns a transferred call if it is not answered after a specific number of rings. The number of rings is programmed by your Customer Service representative. Transfer Callback does not apply to calls transferred externally.

Trunk: A physical connection between the Norstar system and the outside world using either the public telephone system or a private network.

Trunk Answer: A feature you can use to answer a call on any line that has an active Service Mode, even if that line does not appear on your telephone. Trunk Answer is activated in Administration programming.

U

Unsupervised Conference: A conference that you have dropped out of leaving the other two parties connected. When both other parties are external to Norstar, at least one of the outside callers must have called you, and that call must be on a disconnect supervised line. See Disconnect Supervision.

Unsupervised line: A line for which disconnect supervision is disabled. If an external caller hangs up, the Norstar system does not detect the disconnection and does not hang up its line. See Disconnect Supervision.

User Filter: See Dialing filter.

V

Voice Call: A feature you can use to make an announcement or begin a conversation through the speaker of another telephone in the Norstar system. The telephone you call does not ring. Instead, the person you call hears a beep and then your voice. Their telephone beeps periodically to remind them that their microphone is on.

Index

A

- Access Code
 - External line 3-52
- Access denied
 - Conference 3-41
 - Speed Dial 3-98
- Accidental Disconnect
 - Protection 3-100
- Administration
 - Dialing filters 2-24
 - Direct-Dial 2-23
 - entering 2-11
 - exiting 2-11
 - headings 2-9
 - moving through 2-12
 - Names 2-17
 - overview 2-9
 - Programming reminders 2-48
 - Service Modes 2-38
- Administration programming 1-1
- Allow redirect
 - programming 2-33
- Already joined
 - Dialing 3-54
- Already Parked
 - Call Park 3-31
- Answer button 3-34, 3-84
- Answerback (see Handsfree Answerback)
- Autobumping
 - feature description 3-23
- Autodial
 - buttons 3-85
 - feature description 3-13
 - Host System Signaling 3-15
 - losing data after power failure 3-15

Autodial full

- Autodial 3-13
 - Speed Dial 3-98
- Automatic Call Information 2-44
- Automatic Dial 3-46
- Automatic Handsfree 3-45
 - programming 2-31
- Automatic telephone relocation 3-100

Auxiliary Ringer

- programming 2-32
- Service Modes 2-41

B

- Background Music 3-100
- Button
 - Answer 3-84
 - Autodial 3-85
 - erasing programming 3-59
 - Feature 3-84
 - Hold 3-84
 - indicators 3-8
 - Line 3-85
 - Memory 3-84
 - Programmed feature 3-85
 - Release 3-86
 - Volume 3-86
- Button erased
 - Autodial 3-14
- Button Inquiry
 - feature description 3-59

C

- Call Display information 1-3, 3-6
- Call Display services 1-3
- Call Duration Timer 3-105
- Call Forward
 - feature description 3-16
 - No Answer 2-33, 3-16
 - On Busy 2-32, 3-16
 - Override 3-16
- Call Identification 2-43, 2-44, 2-45
- Call Information
 - before or after answering 3-19
 - feature description 3-19
 - for a call on hold 3-20
- Call Log 1-6
 - add digits to a number 3-25
 - call from 3-25
 - choose logging options 3-22
 - entering 3-23
 - erase log items 3-24
 - feature description 3-21
 - navigating within 3-24
 - optional password 3-26
 - space 2-42
 - trim a number 3-25
- Call Park 3-7
 - feature description 3-31
- Call Pickup 3-7
 - assigning groups 3-35
 - feature description 3-33
 - priority of alerting calls 3-34
- Call Pickup (group)
 - programming 2-30
- Call Queuing 3-7
 - feature description 3-36
 - queuing priorities 3-36
- Callback 3-6
- Calls
 - incoming indicators 3-12
- Camp-On
 - answering camped call 3-38
 - feature description 3-37
 - ringing 3-8
- Camp denied
 - Camp-On 3-37
- Can't ring again
 - Dialing 3-55
- Can't send msg
 - Message 3-80
- Cancel
 - feature 3-4
- Cancel denied
 - Message 3-80
- Cancel for
 - Message 3-81
- Capabilities
 - Dialing filters 2-24
 - Line filter 2-37
 - User filter 2-37
- Class of Service 3-101
- Class of Service password (see COS Password)
- Conference
 - disconnect one party 3-39
 - feature description 3-39
 - independently hold two calls 3-40
 - on M7100 telephone 3-43
 - put on hold 3-40
 - split 3-40
 - Transferring 3-41
 - Unsupervised 3-41
 - with Privacy 3-39
- Conference busy
 - Conference 3-41
- Configuration programming 1-1
- Contrast Adjustment 3-45
- Control telephone 3-94
 - assigning to lines 2-38
- Copy

- Capabilities programming
 - 2-47
 - line programming 2-47
 - telephone programming 2-47
- COS Line filter (see Line filter)
- COS Password 2-35
 - changing 3-44
 - copying data 2-36
 - feature description 3-44
 - Line filter 2-37
 - number of 2-36
 - User filter 2-37
- Customizing Norstar 2-9
- Customizing the telephone
 - Automatic Handsfree 3-45
 - Contrast Adjustment 3-45
 - Dialing Modes 3-46
 - Language 3-47
 - moving line buttons 3-48
 - Pulse/Tone dialing 3-49
 - Ring Type 3-49
 - Ring Volume 3-50
 - Telephone Administration
 - Lock 3-51
- D**
- Defaults
 - Dialing filters 2-28
- Delayed Ring Transfer 3-6
- Denied in admin
 - Line Redirection 3-73
 - Service Modes 3-92
- Dial-0 telephone (see Direct-Dial telephone)
- Dialing
 - Direct-Dial 3-52
 - Pulse or Tone 3-49
 - unrestricted 2-28
- Dialing filters
 - defaults 2-28
 - deleting 2-27
 - number of 2-26
- Dialing Modes
 - Automatic 3-46
 - Pre-Dial 3-46
 - Standard 3-46
- Direct-Dial telephone 3-94
- Directed Pickup
 - feature description 3-33
- Directory Numbers 3-101
- Disconnect Protection (see Accidental Disconnect Protection)
- Disconnect Supervision 3-2, 3-102
- Display
 - one-line 3-3
 - Prime telephone 3-11
 - two-line 3-3
- DND (see Do Not Disturb)
- Do Not Disturb 3-7, 3-16
 - feature description 3-58
- E**
- Emergency calls
 - Priority Call 3-90
- Emergency telephone 3-95
- Enter code
 - Speed Dial 3-98
- Enter zone
 - Page 3-89

Exceptions

- in a Dialing filter 2-28
- removing 2-27

Exclusive Hold

- feature description 3-66

Extension numbers (see

Directory Numbers)

External Autodial 3-13

External call

- ringing 3-8

External line

- Line/telephone filter 2-29

External line access code 3-52

Extra-Dial telephone 3-95

- additional Direct-Dial 2-40

F

Feature

- availability 3-2
- canceling 3-4
- overview 3-2
- restrictions 2-30

Feature button 3-84

- programmed 3-85

Feature programming 3-59

Filter

- Line 2-35
- Line with COS 2-37
- Line/telephone 2-29
- Telephone 2-29
- User 2-37

Forward denied

- Call Forward 3-17

Forwarding (see Call Forward)

- Call Forward No Answer 2-33
- Call Forward On Busy 2-32

Full Handsfree

- programming 2-31

G

Get call first

- Call Park 3-31

Group Listen

- feature description 3-62

Group Pickup

- feature description 3-33

H

Handsfree

- Automatic 2-31
- etiquette 3-64

Full Handsfree 2-31

Handsfree Answerback 2-31

Handsfree/Mute 3-7

- feature description 3-63

Headset

- answering a call 3-86
- Full Handsfree 2-31
- operating 3-86

Hold

- feature description 3-65
- Listen on Hold 3-65
- Music, Tones or Silence 3-66
- on M7100 telephone 3-66

Hold button 3-84

Hold or release

- feature programming 3-60

Host System Signaling 3-67

Link 3-67

Pause 3-67

Programmed Release 3-68

Run/Stop 3-68

Timed Release 3-68

Hotline

- programming 2-34

Hotline telephone 3-95

Hung lines

- releasing 3-102

I

- Indicators 3-12
- Internal Autodial 3-13
- Internal call
 - ringing 3-8
- Internal numbers (see Directory Numbers)
- Invalid zone**
 - Page 3-89

L

- Language choice 3-47
- Last Number Redial
 - feature description 3-52
- Line
 - appearance 3-102
 - Hung 3-102
 - indicators on telephones 3-8
 - moving line buttons 3-48
 - Names 2-19
 - Prime 3-104
 - Private 3-103
 - Ringling preference 3-104
 - supervision 3-102
- Line Abilities
 - Line filter 2-35
- Line button 3-85
- Line filter
 - (COS) defaults 2-37
 - (COS) programming 2-37
 - defaults 2-35
 - programming 2-35
- Line in use**
 - Hotline 3-96
- Line Pool 3-103
 - feature description 3-70
 - Hotline 2-34
 - Ring Again 3-71
 - System Speed Dial 2-15

- Line Redirection 3-17
 - Allow redirect 2-33
 - Call Forward No Answer 2-33
 - Call Forward On Busy 2-33
 - feature availability 3-2
 - feature description 3-72
 - Redirect ring 2-34
- Line/telephone filter
 - number of 2-30
- Link
 - feature description 3-67
- Listen on Hold 3-65
- Logit
 - feature description 3-22
- Long Tones
 - feature description 3-77

M

- M7100 telephone
 - Conferencing 3-43
 - Hold 3-66
 - no display buttons 3-3
 - selecting lines 3-5
- M7208 telephone
 - no display buttons 3-3
- Make call first**
 - Camp-On 3-38
- Make calls first**
 - Conference 3-41
- Memory button 3-84
 - erasing 3-59
 - programming 3-59
- Message denied**
 - Message 3-81
- Message Waiting 1-11
- Message Waiting List
 - calling from 3-79

Messages

- feature description 3-78
- Message Waiting List 3-79
- Voice Message Center 3-83

Music on Hold 3-66

N

Names

- entering letters 2-8
- for lines 2-19
- for telephones 2-18
- length 2-17
- moving telephones 2-17
- programming 2-17
- System Speed Dial 2-16
- valid characters 2-17

Need Handsfree

- Headset 3-87

Night Service

- Service Modes 3-92

No button free

- Dialing 3-55
- Message 3-82

No calls waiting

- answering the telephone 3-9

No last number

- Last Number Redial 3-55

No line selected

- answering the telephone 3-9
- Dialing 3-55
- Hotline 3-96

No line to use

- Line Redirection 3-73

No number saved

- Saved Number Redial 3-55

No saved number

- Saved Number Redial 3-56

No voice call

- Voice Call 3-112

Not in service

- Camp-On 3-38

Numbers

- entering 2-7
- viewing 2-7

O

On-hook dialing 3-46

Open Switch Interval (see OSI)

OSI 3-2, 3-102

Outgoing line

- Line Redirection 3-73

P

Page

- feature description 3-88
- selecting a zone 3-88

Page timeout

- Page 3-89

Page zone

- programming 2-32

Paging

- programming 2-32
- zones 2-32

Paging busy

- Page 3-89

Park denied

- Call Park 3-32

Parking full

- Call Park 3-32

Password

- Administration 2-42
- Class of Service (COS) 3-44

Pause

- feature description 3-67

Personal programming 1-1

Personal Speed Dial 3-97

Pick up receiver

- Call Queuing 3-10

Pickup (see Call Pickup)

Pickup denied

- Call Pickup 3-34

- Pool code**
 - Line Redirection 3-74
 - Pre-Dial** 3-46
 - Prime line** 3-104
 - Hotline 2-33
 - Prime telephone** 3-7, 3-96
 - Priority Call**
 - feature description 3-90
 - ringing 3-8
 - Priority denied**
 - Priority Call 3-90
 - Privacy**
 - creating a Conference 3-39
 - Private line** 3-103
 - Call Pickup 2-31, 3-34
 - Program and HOLD**
 - feature programming 3-61
 - Programmed Release**
 - feature description 3-68
 - Programming**
 - Allow redirect 2-33
 - Automatic Handsfree 2-31
 - Auxiliary Ringer 2-32
 - Call Forward No Answer 2-33
 - Call Forward On Busy 2-32
 - Call Pickup (group) 2-31
 - Capabilities 2-24
 - COS Line filter 2-37
 - features 3-59
 - Full Handsfree 2-31
 - Handsfree Answerback 2-31
 - Hotline 2-34
 - Names 2-17
 - Page zone 2-32
 - Paging 2-32
 - preparing for 2-2
 - purpose 2-1
 - Redirect ring 2-34
 - reminders 2-48
 - Service Mode name 2-39
 - Service Modes 2-38
 - Telephone filter 2-28
 - tools 2-3
 - Trunk Answer 2-40
 - using display buttons 2-6
 - Programming Overlay** 2-3
 - Programming Record** 2-3
 - Pulse dialing** 3-49
- R**
- Receive tones** 2-34
 - Redir by**
 - Line Redirection 3-74
 - Redirect ring**
 - programming 2-34
 - ringing 3-8
 - Release a call**
 - answering the telephone 3-10
 - Release button** 3-86
 - Restricted call**
 - Dialing 3-56
 - Line Redirection 3-74
 - Restrictions**
 - bypassing 2-16
 - in a Dialing filter 2-28
 - number of 2-26
 - removing 2-26
 - Ring Again**
 - feature description 3-53
 - Ring Type** 3-49
 - Ring Volume** 3-50
 - Ringling**
 - changing the type 3-49
 - changing the volume 3-50
 - Line preference 3-104
 - Service Modes 2-41
 - Run/Stop**
 - feature description 3-68

S

- Saved Number Redial
 - feature description 3-53
- Selective Line Redirection (see Line Redirection)
- Service Modes 2-38
 - activate and deactivate 2-39
 - Auxiliary Ringer 2-41
 - canceling 3-92
 - Control telephone 2-38, 3-92
 - default start and stop times 2-40
 - Extra-Dial telephone 2-40, 3-93, 3-95
 - feature description 3-92
 - programming 2-38
 - Ringling 2-41
 - Trunk Answer 2-41
- Signaling
 - Host System 3-67
- Speaker
 - Page 3-88
 - telephone 2-31
- Speed Dial
 - Class of Service 3-99
 - feature description 3-97
 - personal programming 3-97
- Standard Dial 3-46
- Supervision (see Disconnect Supervision)
- System Coordinator's role 1-1
- System Speed Dial 3-104
 - bypassing restrictions 2-16
 - changing name 2-16
 - Display Digits 2-15
 - programming 2-13

T

- Telephone
 - Administration Lock 3-51
 - Control 3-94
 - Customizing 3-45
 - Direct-Dial 2-23, 2-32, 3-94
 - Emergency 3-95
 - Extra-Dial 3-95
 - Hotline 3-95
 - Names 2-17
 - Prime 3-7, 3-96
 - relocation 3-100
- Telephone Abilities
 - Allow redirect 2-33
 - Automatic Handsfree 2-31
 - Auxiliary Ringer 2-32
 - Call Forward No Answer 2-33
 - Call Forward On Busy 2-32
 - Call Pickup (group) 2-31
 - Direct-Dial telephone 2-32
 - Full Handsfree 2-31
 - Handsfree Answerback 2-31
 - Hotline 2-34
 - Line/telephone filter 2-29
 - Page zone 2-32
 - Paging 2-32
 - Priority Call 2-35
 - Redirect ring 2-34
 - Telephone Administration Lock 2-30
- Telephone buttons
 - Norstar Telephones 3-84
- Telephone Feature Card 2-3
- Telephone User Cards 2-3
- Their list full
 - Messages 3-82
- Time
 - call duration 3-105
 - display while on a call 3-105
 - feature description 3-105

Time and Date
 setting the date 2-22
 setting the time 2-21
Timed Release
 feature description 3-68
Tone dialing 3-49
Tones
 Long 3-77
 Receive 2-34
Tones denied
 Long Tones 3-77
Transfer
 feature availability 3-2
 feature description 3-106
 using Hold 3-107
 using Unsupervised
 Conference 3-107
Transfer denied
 Transfer 3-109
Trunk Answer
 feature description 3-33
 programming 2-41

U

Unequipped line
 Line Redirection 3-74
Unsupervised Conference 3-41
 feature availability 3-2
 Transfer 3-107

V

Voice Call 3-88
 deny 3-111
 feature description 3-111
 Handsfree Answerback 2-31,
 3-111
 muting tones 3-111
Voice Call Deny 3-7
 feature description 3-111
Voice Message Center
 lines 2-46
 telephone numbers 2-46
Volume button 3-86

Y

Your list full
 Messages 3-82

teleanuals.com

telemanuals.com

telemanuals.com

Norstar Programming Overlay

Heading

Show

Back

Next

P0698666 Issue 02
Printed in Canada

208 Programming Overlay

<input type="text"/>	Copy Yes
<input type="text"/>	Backspace No
<input type="text"/>	Change Remove
<input type="text"/>	Add Default
<input type="text"/>	Heading Retry
<input type="text"/>	Show <-- View -->
<input type="text"/>	Back
<input type="text"/>	Next OK

P0714755 01

